

Chroma-Q™ Daylight PAR™

User Manual



Version 1.1 December 2006

PN: 147-0500

Disclaimer

The information contained herein is offered in good faith and is believed to be accurate. However, because conditions and methods of use of our products are beyond our control, this information should not be used in substitution for customer's tests to ensure that Chroma-Q products are safe, effective, and fully satisfactory for the intended end use. Suggestions of use shall not be taken as inducements to infringe any patent. Chroma-Q sole warranty is that the product will meet the sales specifications in effect at the time of shipment. Your exclusive remedy for breach of such warranty is limited to refund of purchase price or replacement of any product shown to be other than as warranted.

Chroma-Q reserves the right to change or make alteration to devices and their functionality without notice due to our on going research and development.

The Chroma-Q Daylight PAR has been designed specifically for the professional entertainment lighting industry. Regular maintenance should be performed to ensure that the products perform well in the entertainment environment.

If you experience any difficulties with any Chroma-Q products please contact your selling dealer. If your selling dealer is unable to help please contact support@chroma-q.com. If the selling dealer is unable to satisfy your servicing needs, please contact the following, for full factory service:

Outside North America:

Tel: +44 (0)1494 446000
Fax: +44 (0)1494 461024
support@chroma-q.com

North America:

Tel: 416-255-9494
Fax: 416-255-3514
support@chroma-q.com

For further information please visit the Chroma-Q website at www.chroma-q.com.

Chroma-Q is a trademark, for more information on this visit www.chroma-q.com/trademarks.

The rights and ownership of all trademarks are recognised.

Table of Contents

1. Product Overview	3
2. Operation	3
2.1 Unpacking the unit	3
2.2 Caution/warning symbols and safety instructions	4
2.3 Power requirements	5
2.4 Fixture set-up and installation	5
2.5 Operating the unit	8
2.6 Troubleshooting	11
2.7 Technical overview	11
2.8 Technical specifications	12
3. Drawings	13
3.1 Outside dimensions	13

1. Product overview

The Chroma-Q Daylight PAR is designed to give years of trouble free use, providing that it is regularly maintained and is used in accordance with the instructions detailed in this manual.

Introduction

The Chroma-Q Daylight PAR is a DMX controlled high output, daylight colour temperature fixture with 95% CRI, interchangeable optics and the added versatility of DMX control of all the main functions, making it a truly multipurpose fixture. The compact and stylish design is equally at home in a theatre, film or TV studio, exhibition centre, shopping mall, or car showroom.

Light source and optics

The MSR 575 HR lamp is a high output metal halide arc lamp, with high luminous efficacy, and a constant 95% CRI (Colour Rendering Index) and 6000°K colour temperature. The use of a polished, enhanced aluminium reflector and four interchangeable lenses to vary the beam spread give the fixture excellent versatility. The 'Hot Restrike' facility means the lamp does not have to cool after power down and is always ready for use.

DMX control/stand-alone use

The Chroma-Q Daylight PAR is designed to operate on the ANSI E1.11 USITT DMX 512-A protocol. This multiplexed serial data system allows for the individual addressing of multiple units on one data cabling system. The unit is addressed by using the three push button switches and LED display. The DMX signal allows remote control of lamp on/off, dimming (partial) and 'power/lamp saving' mode. The unit equipped with a diagnostic section on the LED display showing power, DMX signal and level presence.

Power

The Chroma-Q Daylight PAR is designed for worldwide use and does not require any alteration to function on the standard voltages/frequencies available. The electronic lamp power supply increases the lamp output and can extend the working life of the lamp.

2. Operation

- 2.1 Unpacking the unit
- 2.2 Caution/warning symbols and safety instructions
- 2.3 Power requirements
- 2.4 Fixture set-up and installation
- 2.5 Operating the unit
- 2.6 Troubleshooting
- 2.7 Technical overview
- 2.8 Technical specifications

2.1 Unpacking the unit

The Chroma-Q Daylight PAR package comes with the following items:

- Chroma-Q Daylight PAR
- Colour frame/mesh
- Set of 4 interchangeable lenses
- User manual

The unit is shipped in a specially constructed shipping carton to provide protection to the unit. The packing material protects the fixture; always use it to transport the fixture.

Further copies of this manual may be downloaded from the Chroma-Q website - www.chroma-q.com.

Caution/warning symbols and safety instructions

The following International symbols are used throughout this manual and on the unit to identify warning and caution messages.



Caution:

This symbol appears adjacent to caution messages. Failure to heed these messages could result in personal injury and damage to equipment.



Warning:

This symbol appears adjacent to High Voltage Warning messages. Failure to heed these messages could result in serious personal injury and damage to equipment.



Hot Surface:

This symbol indicates a hot surface. Failure to heed these messages could result in personal injury and potential fire risk.



Explosion Risk:

This symbol indicates a potential explosion risk from high-pressure lamps. Always wear eye protection and clothing as per lamp manufacturers' guidelines. Failure to heed these messages could result in personal injury.



Eye Protection Required:

This symbol indicates that eye protection is required due to a potential explosion risk. Failure to heed these messages could result in personal injury.



Minimum Safe Distance:

This symbol indicates the minimum distance to an illuminated object should be at least, 1.5 metres (4.5 ft). Failure to heed these messages could result in a potential fire risk.

Safety instructions

**This product is for professional use only.
It is NOT intended for domestic or outdoor use.**

- Please read the entire user manual before using this equipment.
- Disconnect the unit from its power source before removing or installing the lamp, fuses or any other part, performing cleaning and maintenance, and when not in use.
- Ensure the unit has the proper electrical supply connections and is grounded.
- The unit must be connected to an AC electrical supply that has suitable fault protection.
- Always rig the unit with care and use an approved means of secondary attachment e.g. a safety wire.
- Do not expose the unit to rain or moisture of any kind.
- Never operate the unit with missing or damaged covers or lenses.
- When installing or replacing the lamp always disconnect the unit, allow 15 minutes cooling, and use the recommended protective safety equipment.
- Always replace the lamp if it becomes damaged or thermally deformed. Do not run lamps for more than the manufacturers recommended number of hours.
- Do not mount the unit on or near flammable materials and ensure the unit is 1.5 metres (4.5ft) away from anything it is shining on.
- Allow the unit to cool for at least 5-10 minutes before handling it.
- Servicing must only be carried out by the manufacturer or by other suitably qualified service personnel.

2.3 Mounting the unit

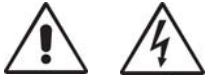

The Chroma-Q Daylight PAR is designed for worldwide use and does not require any alteration to function on the standard voltages and frequencies generally available.

Voltage range	Frequency	Power Factor	Max Power	Replacement fuses (2x) 5 x 20mm
90-130V AC	47-63 Hz	0.62-0.65	1100VA	2.5A, 250V, 'T' type
198-264V AC	47-63 Hz	0.92-0.95	700VA	5A, 250V, 'T' type

2.4 Fixture set-up and installation

Lamp installation



- Replace the lamp at the end or before the end of its rated life (see lamp manufacturers' literature). Failure to replace a lamp at this time can increase the chance of the quartz glass envelope exploding.
- Before installing/replacing a lamp, please ensure the power has been shut off, the unit unplugged and the fixture left to cool for 10-15 minutes.
- Please observe the lamp manufacturers guidelines with respect to the personal safety equipment recommended to install/replace a lamp in the fixture.
- Do not touch the lamp with bare hands. If touched by bare hands, clean the lamp with isopropyl alcohol (C3H7OH) and a lint free cloth.

To install/replace the lamp



You will need:

- MSR 575 HR lamp
 - Philips screwdriver
 - Suitable personal protective equipment
1. Ensure the unit has been unplugged from its power source, and is cooled sufficiently to work on.
 2. Using a Philips screwdriver, unscrew the lamp release screw on the rear of the lamp housing.

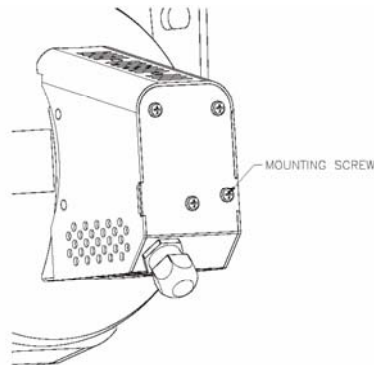

- Once the screw is completely loose, carefully remove the lamp housing from the reflector housing by gently pulling it straight back. Trying to remove the lamp housing at an angle will cause the lamp envelope to rub against the reflector opening and risks damaging the quartz glass envelope (see diagrams below).

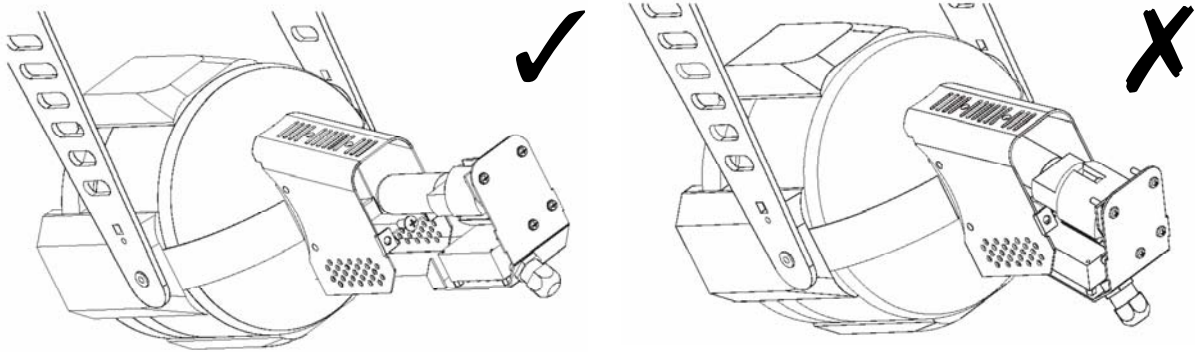

- Wearing a pair of gloves and holding the lamp by its ceramic base, carefully remove the old lamp from the holder.
- Insert the new lamp into the socket assembly and gently push down until the lamp seats correctly.
- Re-insert the lamp housing onto the back of the reflector housing by starting to gently guide the lamp envelope through the opening in the reflector. Then line up the guide pin and gently push the lamp housing into position. Trying to insert the lamp housing at an angle will cause the lamp envelope to rub against the reflector opening and risks damaging the quartz glass envelope.
- Tighten up the lamp housing retaining screw.
- The unit is now ready for use, although the lamp position may need to be optimised to achieve the best performance from the fixture (see: next section).

Optimising the lamp



- Turn on the fixture, aim the light towards a flat surface and allow time to reach full brightness.
- Centre the hot-spot (the brightest section) in the main projected beam using the three Philips headed screws on the back of the lamp housing. Turn one screw at a time to move the hot-spot across the projected beam. If there is no visible hot-spot, adjust the optimising screws until the light is evenly distributed.
- If the hot-spot is too pronounced the lamp is too far forward in the reflector. This hot-spot can be reduced by turning all three screws clockwise 1/4-turn at a time until the light is more evenly distributed.
- If there is a dark spot in the centre of the beam, or the light output appears to be dimmer than expected, the lamp may be too far back in the reflector. This can be reduced by turning all three screws counter-clockwise 1/4-turn at a time until the light is brighter and more evenly distributed.

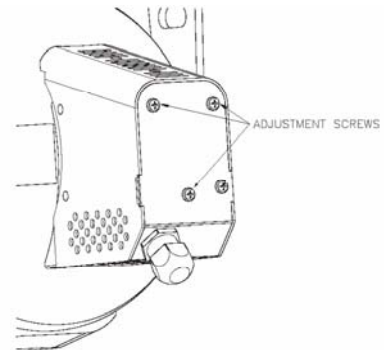

Using colour filters



The Chroma-Q Daylight PAR is equipped with runners designed to take a colour-frame or other accessories, which have 7.5"/190mm outside fitting, 6.7"/170mm minimum diameter opening, and a spring-loaded retaining clip, which prevents the accessories from falling out.

- The fixture may be HOT. Exercise caution.
- To release the clip, push it sideways and back towards the rear of the fixture.
- Insert the colour-frame, or accessory.
- Push the retaining ring forwards until it snaps into the locked position.
- Make sure that the colour-frame retaining clip is in the locked position when the fixture is rigged.
- Use only high-temperature colour media or dichroic glass filters in the unit.

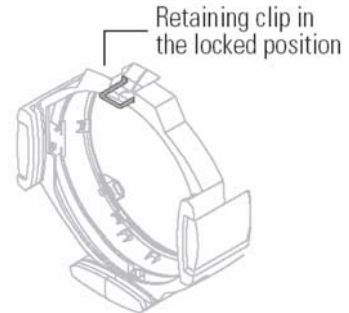

Changing the Daylight PAR lenses

The Daylight PAR comes equipped with four interchangeable lenses allowing a large variation of beam angles from one fixture.

The medium and wide flood lenses will produce an oval beam shape. This can be rotated any direction by moving the black plastic lens retaining ring.

VNSP Very narrow spot 15 circular beam (Clear glass)	NSP Narrow spot 19 circular beam (Pebbled glass)	MFL Medium flood 21 x 34 oval beam (Lightly faceted)	WFL Wide flood 30 x 51 oval beam (Heavily faceted)

- Do not operate the fixture without a lens fitted.
- Before installing/replacing a lens, please ensure the fixture has been unplugged.
- During operation the lenses and retaining ring become very hot. Wear gloves when adjusting the lens retaining ring. Allow the fixture to cool before changing the lens.
- Do not remove lenses in situation where they might fall and cause bodily harm. Work on a flat, stable surface.
- Change the lenses if they become cracked or badly scratched.

Removing a lens

1. Place the fixture on a flat, stable, work surface and rotate the lens retaining ring so that the spring clip is at the top of the fixture.
2. Tilt down the front of the fixture approximately 45°.
3. Use a finger to depress the spring clip, allowing the lens to fall forward.
4. Carefully lift the lens clear of the fixture.

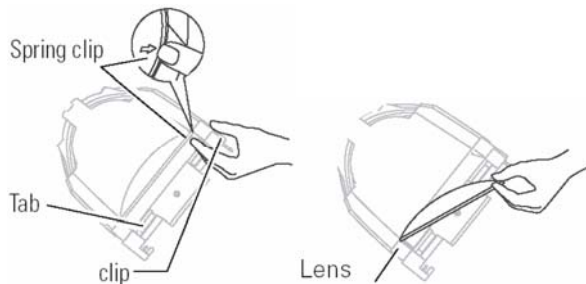

Installing a lens

1. Place the fixture on a flat, stable, work surface and rotate the lens retaining ring so that the spring clip is at the top of the fixture.
2. Tilt up the front of the fixture slightly.
3. Holding the lens by edge, and with the convex side facing the back of the fixture, insert the lens into the retaining ring so that the bottom of the lens is located behind the two tabs at the bottom of the lens retaining ring.
4. Gently push the top of the lens into the retaining ring until it snaps behind the spring clip.

Note: Installing the lens the wrong way round (i.e. convex side outwards) will not affect the optics of the fixture, but it will make subsequent lens removal more difficult and reduce the working life of any colour media used with the fixture.

Connections



Power cord

A plug of the correct voltage and current rating, and suitable for the local power outlets, should be connected to the power cord in accordance with colour code below.

International Colour code	N. American Colour code	Connections	
Green and Yellow	Green	Earth (E)	Ground (green)
Blue	White	Neutral (N)	Neutral (silver)
Brown	Black	Live (L)	Hot (gold)

Important Note: - This unit must be grounded/earthed!

DMX signal cables

The DMX signal uses a 5 pin XLR connectors wired to the ANSI E1.11 USITT DMX 512-A standard. Interconnections should be made using suitable 5pin XLR cable. Please ensure that your DMX cabling follows accepted guidelines and is suitably terminated.

Pin No	Function
1	Screen/shield (0 V)
2	Data comp. (-ve)
3	Data true (+ve)
4	No connection
5	No connection

2.5 Operating the unit

All the unit functions are accessed using the LED display and the three push-button switches on the rear panel.

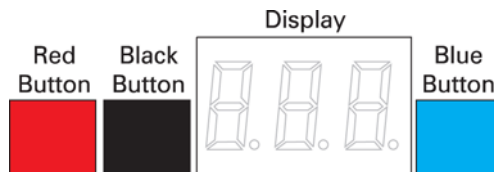

Control	Function
Red Button	Mode access and record
Blue Button	Decrements (-) the mode level or value
Black Button	Increments (+) the mode level or value
3 Digit Display	Displays mode, monitor or blank display

Display operation

Power-up display

On power-up the display will show the DMX address mode.



Monitor Display

If left undisturbed for 5-7 seconds the display will revert to 'Monitor Mode'.

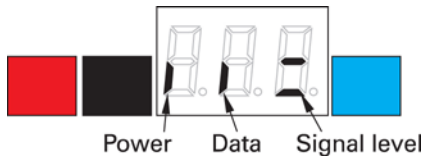

The first vertical bar indicates that there is Power (24V DC).
The second vertical bar indicates that there is Data (DMX).
The horizontal bars indicate the data Signal Level (DMX).
(See also: 'Troubleshooting' section of this manual)

Display Flip

The display-viewing angle can be flipped through 180° by pressing and holding the RED button, then pressing the BLACK button.

Reset

If the RED button is held down and the BLUE button pressed, the unit will reset to the factory default settings.



Push button operation

The RED button is used to scroll through the different modes of operation. The BLUE or BLACK buttons are used to select the level or value in that mode.

If any mode or value is changed the display will flash until the RED button is pushed to record the change.

Modes of operation

Stand-alone mode

In this mode, the unit can be used without a DMX control signal.

To use the stand-alone mode;

- Connect the unit to a suitable power outlet.
- Press the RED button to access the lamp power mode.
- Using the BLUE or BLACK button, scroll through the menu until the display reads LPL (low power) or LPF (full power), and press the RED button to record.
- To switch off, use the BLUE or BLACK button, scroll through the menu until the display reads LPO (lamp off), and press the RED button to record.

DMX addressing mode

This mode is used to set DMX data address of the unit. The unit uses one DMX channel.

The display shows the current DMX address (between 1-512).

(To alter the address, press button once to increment / decrement the value; hold down the button for fast increments/ decrements of the value.)

Lamp power/control mode (LP)

This mode is used to set the control mode of the unit. The unit operates either controlled by one channel of DMX data, or in stand-alone mode (with no DMX).

When in stand-alone mode the user can select lamp off, lamp on (low power), or lamp on (full power).

In DMX control mode: the user has full control of lamp on/off and lamp dimming.

DMX value = 0-10% off, 10-50% 'Lamp Saver' low power, 50-100% dim to full power

Display mode (dP)







This mode is used to switch the display on or off. This feature can be used to blank the displays that may be an unwanted distraction after 5-7 secs.

The display will re-activate when any button is pressed.

Press to switch between on (1) and off (0).

Summary of control functions

Modes (Use the RED button to scroll through these modes)

Mode	Description	Actions required	Display
DMX addressing mode	Used to set the units DMX data address	Press BLUE or BLACK button once to increase/decrease the value; hold down the button for fast increment/decrement.	The display shows DMX address in the range 1-512. 
Lamp Power	Used to switch the fixture on/off, low/high power settings, or via DMX control/lamp saver modes	To alter the mode, press BLUE or BLACK button once to switch between modes.	The display shows that the lamp is OFF. 
			The display shows that the lamp is at LOW power 
			The display shows that the lamp is at HIGH power 
			The display shows that the lamp is set for DMX control. 
Display	Switches display on/off	To alter the mode, press BLUE or BLACK button once to switch between modes. (Display will re-activate when any button is pressed.)	This shows that the display is set for auto-blanking. 
			This shows that the display is set to be permanently on. 

Default Settings

'Factory' default settings

If the unit is reset, using the RED button (held down), and the BLUE button pressed, the unit will reset to the factory default settings.



The 'Factory' default settings put the unit in its safest operating mode.

- Lamp on/off = Off
- Display = On
- Display Flip = Normal

'User' default settings

Each time the RED record button is pressed, the unit will save that change and these 'user defaults' will take precedence on the next power cycle or remote reset.

These 'User' defaults can be reset to the 'factory' defaults using the method detailed above.

Mounting the unit



- Always rig the unit with care and use an approved means of secondary attachment e.g. a safety wire.
- Do not mount the unit on or near flammable materials.
- Ensure the unit is at least 1.5 metres (4.5ft) away from anything it is shining on.
- Make sure that the colour-frame retaining clip is in the locked position when the fixture is rigged.
- Do not operate the fixture without a lens fitted.

2.6 Troubleshooting

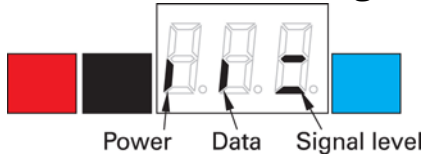

The first vertical bar indicates that there is Power (24V DC).
 The second vertical bar indicates that there is Data (DMX).
 The horizontal bars indicate the data Signal Level (DMX).

Note: The signal level changes during normal operation of the unit 1st bar = 25%, 2nd bar = 50%, 3rd bar = 75%

Symptom	Possible Cause	Solution
Unit does not respond to DMX, but DMX display indicator is on.	Unit set to wrong or different DMX address.	Check DMX address settings.
Unit does not respond to DMX, DMX display indicator is off.	Bad cable. No DMX at splitter/PSU.	Check cable and DMX run from the console.
Lamp does not strike.	Unit set to wrong or different DMX address. Bad cable. No DMX at splitter/PSU. Set in wrong mode. Blown lamp.	Check DMX address settings. Check cable and DMX run from the console. Check mode settings on unit. Replace lamp.

2.7 Technical overview

Troubleshooting is a process of elimination. First, rule out the other field factors (i.e. faulty cables, power sources). Servicing must only be carried out by the manufacturer or by other suitably qualified service personnel. For technical advice and/or parts, please contact your selling dealer or the offices listed in this manual.

2.8 Technical specifications

Dimensions:	327 x 229 x 458mm / 12.9" x 9.0" x 18."
Weight:	7.6kg / 17.0 lb
Lamp type:	MSR 575HR or equivalent
Lamp colour temp*:	6000°K
Lamp initial lumens*:	49,000 lm
Lamp colour rendering index*:	95%
Lamp life:	1000 hrs, replace after 1200 hrs max
Lamp dim*:	60% of full brightness
Lamp cooling:	Natural convection
PSU cooling:	Temperature controlled, variable speed, low noise fan
Maximum ambient temperature:	Tamb = 40°C/105°F
Maximum surface temperature:	Tmax = 185°C/365°F
IP rating:	IP20
Addressing:	Digitally, via push buttons (3) and LED display
Working Voltage:	90-264V AC
Power consumption:	1110 VA (Max.)
Fuses:	5 x 20mm 'T' type
Fuse rating:	12.5 Amp @ 115V AC 5 Amp @ 230V AC
DMX protocol:	ANSI E1.11 USITT DMX 512-A
Body color:	Black powder coat (other colours available, POA)
Signal connectors:	XLR-5, in and through
Approvals:	EN/IEC 60598-1:2000 and 2-17:89+A2:91

Note: (*) = Manufacturers figures. Actual figures may vary depending on lamp type, age, and condition.



3. Drawings

3.1 Outside dimensions

