

Chroma-Q®

Studio Force II™ V12/ V48/ V72

User Manual



Chroma-Q®
BRILLIANT SOLUTIONS

Part Number: CHSF2V12, CHSF2V12LR, CHSF2V12W,
CHSF2V48, CHSF2V48LR, CHSF2V48W,
CHSF2V72, CHSF2V72LR, CHSF2V72W
(**Model:** 652-1150, 652-1650, 652-1250,
641-4000, 641-4100, 641-4500,
641-5000, 641-5100, 641-5500)

Software Version 1.4

Manual: 641-0906 V1.2

Warranty Statement

Chroma-Q warrants to the original purchaser, with proof of purchase, that its delivered products shall be free from defects in material and workmanship under normal use for a period of 24 months from date of shipment.

Chroma-Q will repair, or at its option, provide an equivalent item or replace, the defective product during the stated warranty period. This warranty applies only to the repair or replacement of the product and only when the product is properly handled, installed and maintained according to Chroma-Q instructions. This warranty excludes defects resulting from improper handling, storage, installation, acts of God, fire, vandalism or civil disturbances. Purchaser must notify Chroma-Q in writing within 14 days of noticing the defect. This warranty excludes field labor or service charges related to the repair or replacement of the product.

The warranty contained herein shall not extend to any finished goods or spare parts from which any serial number has been removed or which have been damaged or rendered defective (a) as a result of normal wear and tear, willful or accidental damage, negligence, misuse or abuse; (b) due to water or moisture, lightning, windstorm, abnormal voltage, harmonic distortion, dust, dirt, corrosion or other external causes; (c) by operation outside the specifications contained in the user documentation; (d) by the use of spare parts not manufactured or sold by Chroma-Q or by the connection or integration of other equipment or software not approved by Chroma-Q unless the Customer provides acceptable proof to Chroma-Q that the defect or damage was not caused by the above; (e) by modification, repair or service by anyone other than Chroma-Q, who has not applied for and been approved by Chroma-Q to do such modification, repair or service unless the Customer provides acceptable proof to Chroma-Q that the defect or damage was not caused by the above; (f) due to procedures, deviating from procedures specified by Chroma-Q or (g) due to failure to store, install, test, commission, maintain, operate or use finished goods and spare parts in a safe and reasonable manner and in accordance with Chroma-Q's instructions (h) by repair or replacement of engines without factory training.

The warranty contained herein shall not apply to finished goods or spare parts which are sold "as is", as "second-hand", as "used", as "demo" or under similar qualifications or to Consumables ("Consumables" is defined as any part(s) of goods or part(s) for use with goods, which part(s) of goods or part(s) for use with goods are consumed during the operation of the goods and which part(s) of goods or part(s) for use with goods require replacement from time to time by a user such as, but not limited to, light bulbs).

The warranty contained herein shall not apply, unless the total purchase price for the defective finished goods or spare parts has been paid by the due date for payment.

The warranty contained herein applies only to the original purchaser and are not assignable or transferable to any subsequent purchaser or end-user.

This warranty is subject to the shipment of the goods, within the warranty period, to the Chroma-Q warranty returns department, by the purchaser, at the purchaser's expense. If no fault is found, Chroma-Q will charge the purchaser for the subsequent return of the goods.

Chroma-Q reserves the right to change the warranty period without prior notice and without incurring obligation and expressly disclaims all warranties not stated in this limited warranty.

Disclaimer

The information contained herein is offered in good faith and is believed to be accurate. However, because conditions and methods of use of our products are beyond our control, this information should not be used in substitution for customer's tests to ensure that Chroma-Q products are safe, effective, and fully satisfactory for the intended end use. Suggestions of use shall not be taken as inducements to infringe any patent. Chroma-Q sole warranty is that the product will meet the sales specifications in effect at the time of shipment. Your exclusive remedy for breach of such warranty is limited to refund of purchase price or replacement of any product shown to be other than as warranted.

Chroma-Q reserves the right to change or make alteration to devices and their functionality without notice due to our ongoing research and development.

The Chroma-Q Studio Force II™ has been designed specifically for the lighting industry. Regular maintenance should be performed to ensure that the products perform well in the entertainment environment.

If you experience any difficulties with any Chroma-Q products please contact your selling dealer. If your selling dealer is unable to help please contact support@chroma-q.com. If the selling dealer is unable to satisfy your servicing needs, please contact the following, for full factory service:

Outside North America:	North America:
Tel: +44 (0)1494 446000	Tel: 416-255-9494
Fax: +44 (0)1494 461024	Fax: 416-255-3514
support@chroma-q.com	support@chroma-q.com

For further information please visit the Chroma-Q website at www.chroma-q.com. Chroma-Q and Studio Force II™ are trademarks, for more information on this visit <http://www.chroma-q.com/trademarks.asp>. The rights and ownership of all trademarks are recognized.

Important Notice:

As per the requirements in the Occupational Safety and Health Administration standards for product approval, please refer to the OSHA web pages <http://www.osha.gov/dts/otpc/nrtl/> for information on the list of Nationally Recognized Testing Laboratories (NRTLs) and the scope of recognition.



Safety information



WARNING!

Read the safety precautions in this section before installing, powering, operating or servicing this product.

The following symbols are used to identify important safety information on the product and in this document:



**Warning!
Safety Hazard.
Risk of severe
injury or death.**



**Warning!
Fire Hazard.**



**Warning!
Hazardous
Voltage.
Risk of
severe lethal
electric
shock.**



**Warning!
Refer to User
manual.**

Warning!

Read the user manual before installing and operating the Chroma-Q Studio Force II™. For future reference, keep and use the manual.

Safety precautions given in user manual must be followed at all times and the manuals of all the devices you connect it to. Observe all the warnings printed on product and in manuals. Make sure whoever is involved in working on or using the Chroma-Q Studio Force II™ has carefully read and understood all the safety precautions and listed warnings.

- Install, connect, operate and service devices only as described in this manual and in connected devices' manuals and only in accordance with local laws and regulations. All Chroma-Q manuals are available for download from www.chroma-q.com.
- Chroma-Q Studio Force II™ does not have user-serviceable parts. Refer any operation not described in this manual to support@chroma-q.com.

If you experience difficulties with any Chroma-Q products please contact your local dealer. If your local dealer is unable to help then please contact support@chroma-q.com.

If you are having trouble finding what you are looking for on our website, then contact our Chroma-Q marketing department by sending an email to marketing@chroma-q.com.

PROTECTION FROM ELECTRIC SHOCK

- Use only the cables specified in this manual and on the Chroma-Q website at www.chroma-q.com to interconnect devices in the installation. If the specified cables are not long enough for an intended cable run, consult Chroma-Q for assistance in finding or creating a safe alternative solution.
- Provide a means of locking out AC mains power that allows power to the installation to be shut down and made impossible to reapply, even accidentally, during work on the installation.
- Shut down power to the installation during service and when it is not in use.
- Before applying power to the installation, check that all power distribution equipment and cables are in perfect condition and rated for the current requirements of all connected devices.
- Isolate the installation from power immediately if any product, power cable or power plug is in any way damaged, defective or wet, or if it shows signs of overheating.
- Do not immerse a Chroma-Q Studio Force II™ fixture in water or expose it to high-pressure water jets.

PROTECTION FROM BURNS AND FIRE

- The Studio Force II™ is designed to be cooled by forced air convection. Provide free airflow around the fixture and a minimum clearance of 10 mm (0.4 in.) in all directions.
- Do not operate the Studio Force II™ if the ambient operating temperature exceeds 40° C (104°F).
- Do not modify the Studio Force II™ in any way not described in this manual or install other than genuine Chroma-Q parts. Use only accessories approved by Chroma-Q.

PROTECTION FROM INJURY

- Ensure that the installation hardware and supporting surface or structure can hold at least 10 times the weight of all the devices they support.
- Block access below the work area and work from a stable platform whenever installing, servicing or moving the Studio Force II™.
- As soon as work is completed, check that all hardware and components are securely fastened to supporting structures.
- Make sure there are no flammable materials close to the product during operation.
- Make sure the power cord is not crimped or damaged.
- Avoid direct eye exposure to the light source while the product is on.
- Never try to repair the product. Repairs carried out by unskilled people can lead to damage or malfunction and/or invalidate your warranty. Please contact the nearest authorized dealer or contact support@chroma-q.com.



Keep this User Manual for future consultation. If this product is used by another user, be sure that they also receive this document.

Contents

Contents.....	5
1. Product overview.....	7
2. Operation.....	8
2.1. Unpacking the units.....	8
2.2. Cabling.....	8
2.3. Mounting.....	9
2.4. Optics.....	9
<i>Cyc & Border Lens</i>	9
2.5. Control.....	10
2.6. Main Menu.....	11
Configuration option buttons.....	12
DMX 12	
3. <i>Mode</i>	12
3.1. Mode Select Options.....	13
3.2. Mode Options.....	15
3.3. Grouping Options.....	16
3.4. Pixel ordering Options.....	17
3.5. DMX Footprints.....	17
4. <i>Set up Menu</i>	18
4.1. DMX Data.....	19
4.2. Fan Speed.....	19
4.3. Rotate Display.....	19
4.4. PWM Frequency.....	20
4.5. DMX Lost.....	20
4.6. Lock feature.....	21
4.7. Reset and Factory Defaults.....	22
4.8. Upload Engine.....	23
4.9. FW Version.....	23
4.10. DMX Source.....	23
4.11. Engine Temp.....	23
5. Look Store.....	24
6. Thermal Performance.....	25
7. Troubleshooting.....	25
8. Maintenance.....	25
9. Specification.....	26
9.1. Technical specifications.....	26
9.2. Technical Drawings.....	27
<i>Studio Force II 72</i>	27
<i>Studio Force II 48</i>	28
<i>Studio Force II 12</i>	29

10. Menu Tree	30
11. DMX Map	31
11.1. Studio Force II DMX map for RGBW Control Mode:	31
11.2. Studio Force II DMX map for RGB Control Mode:.....	31
11.3. Studio Force II DMX map for HSi Control Mode:.....	32
11.4. Studio Force II DMX map for KHi Control Mode:.....	32
11.5. Studio Force II DMX map for Cine-Q i-KH-RGBW Control Mode.....	33
11.6. Studio Force II DMX map for Cine-Q i-KH-RGBW 16bit Control Mode.....	34
11.7. Studio Force II DMX map group modes	35
11.8. Studio Force II DMX map Control channel	35
12. RDM FUNCTIONS	36
12.1. FREQUENCY, FAN_SPEED and GROUPING	36

1. Product overview

The Chroma-Q Studio Force II™ LED batten range is a powerful lineup of professional lighting industry. With up to **≈36,000/** Studio Force II™ 72, **≈24,000/** Studio Force II™ 48, **≈6,500/** Studio Force II™ 12 hot lumens output, these **super bright fixtures** are specifically **designed** for **TV Broadcast and film applications** but also performs particularly well in other situations demanding high quality tunable white light such as touring key lights, exhibitions, corporate events and theatre lighting.

Optional slide-in "**Cyc Light**" and "**Border Light**" **optical lens accessories** are available to adjust the light output to suit a wide range of applications.

The Chroma-Q Studio Force II™ lighting fixture is designed for **professional indoor entertainment lighting**. The fixture can be **wall or floor mounted** with the adjustable **quick-release end-plate fixing** system. For **hung bar or truss mounting**, additional bar clamp hardware is required.

The Studio Force II™ features **integrated power supplies** and can be operated as a **stand-alone unit or be remotely controlled** through **ANSI E1.11 USITT DMX 512-A protocol** via a **cable or a Lumen Radio wireless connection** (when using the optional RF module).

The Studio Force II™ is available in three lengths, the **Studio Force II™ V72 model** which features a total of **24 high output** cells (or pixels), the **Studio Force II™ V48 model** which features a total of **16 high output cells** (or pixels) and the **Studio Force II™ V12 model** which features a total of **4 high output cells** (or pixels). Each cell provides a **homogenized output** with no unsightly color shadowing like fixtures using traditional individual light emitters.

The **control options** incorporate a choice of KHi (Kelvin, Hue and intensity), Cine-Q (Intensity, Kelvin, Hue, Red, Green, Blue, White and Crossfade between KH and RGBW), RGBW (Red, Green, Blue, and White), RGB (Red, Green, and Blue), HSi (Hue, Saturation and intensity) and control modes.

An extra control parameter channel can be added to any of the modes, the channel will be placed as the last parameter of the fixture.

The product's robust **extruded aluminum construction** houses a discreet cable management system. Additional protection is built around the lenses for a **truly road proof** fixture.

2. Operation

2.1. Unpacking the units

The Studio Force II package includes the Studio Force II fixture, power cord, preinstalled mounting bracket and a Quick Start Guide. It is strongly recommended that original packaging is kept, for the ease of transportation.

2.2. Cabling

The Studio Force II™ utilizes Neutrik powerCON true1 connectors for power input and through connections. The DMX control data input and through connections are via two Neutrik XLR 5-pin male and female connectors. The chassis are ground bonded.

XLR-5 Pinout:

Pin#	Function
1	Ground (Screen)
2	Data Minus
3	Data Plus
4	Spare Data Minus
5	Spare Data Plus

Table 1 (XLR PIN)

Power and Data Input Location

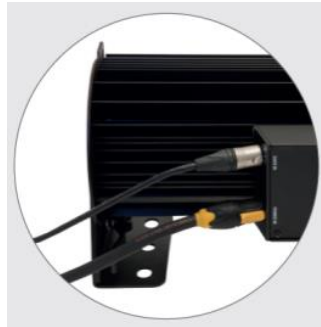

Figure 1 (Connection)

Power Cable Pinout:

International Colour Code	Connections	North American Colour Code	Connections
Green and Yellow	Earth (E)	Green	Ground (Green)
Blue	Neutral (N)	White	Neutral (Silver)
Brown	Live (L)	Black	Hot (Gold)

Table 2 (Power Cable Colour Code)

Important Notice:

The use of an optical splitter for DMX signal distribution is highly recommended when several fixtures are not plugged into the same power source.

Maximum Number of fixtures connected in a series:

Important Notice: Actual number of fixtures connected in series may be lower, based on your branch circuit inrush rating.

Fixture	Wattage	@110V	@220V
SF II 72	800W	2 x SF II 72	4 x SF II 72
SF II 48	550W	3 x SF II 48	6 x SF II 48
SF II 12	150W	10 x SF II 12	20 x SF II 12

Table 3 (Fixtures in series)

2.3. Mounting

The Studio Force II™ fixtures are equipped with built-in mounting brackets or trunnions for floor mounting. The mounting brackets feature a pair of quick release levers for easy tilt adjustment. The hidden lever gives user quick access to unlock/lock the fixture tilt mechanism without using any tools and leaves the fixture side flat to place them next to each other without any gap. Wall and truss mounting applications may require additional hardware.



Figure 2 (SF-II 12 - Quick lever tilt adjustment)

Note: Secure the fixture with a safety bond. Fixing holes are provided in the endplates and fixture brackets.

2.4. Optics

The Studio Force II™ fixtures are built with lenses that optimize the beam spread. The unit comes with preinstalled symmetric lenses for high intensity homogenized output and extremely uniform wash. The beam distribution is symmetrical when Studio Force II™ is used to directly illuminate an area on stage. The fixture throws intense uniform white output at extreme intensity and provides a tight beam angle of $\approx 22^\circ$.



Figure 3 (Symmetrical Lens)

Cyc & Border Lens

“Cyc Lens” and “Border Lens” are slide-in optical accessories available to adjust the light output of the Studio Force II™ fixtures, to suit a wide range of applications. One accessory slot is provided on the front of the fixture to hold a slide-in lens accessory. Matching indentations on both ends of lens are provided for locking the lens in place.

Studio Force II comes standard with a $22^\circ \times 22^\circ$ beam angle optics. 2 additional lenses can be position in front

the standard optics. The output beam angle with Border Lens is 43° x 43° and with CYC Lens , 80°x35°. This can be seen in Figure 4 <<add proper reference for figure>>

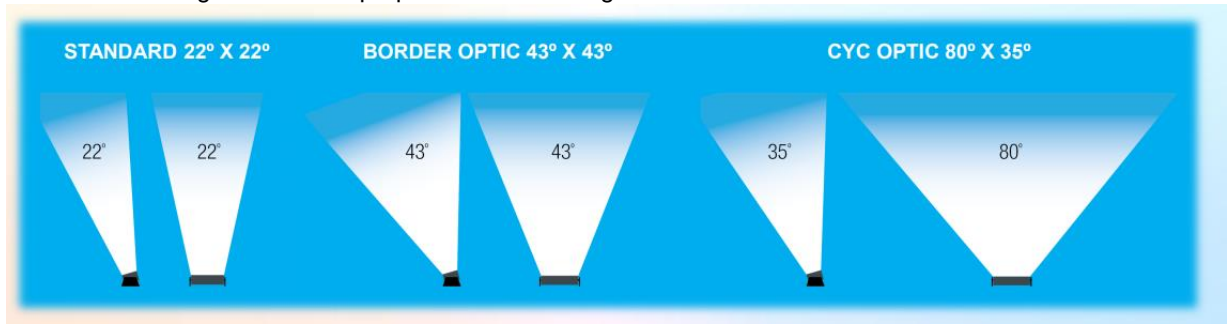

Figure 4 (Beam Angle)

Spring Plungers are pre-installed at the far ends of the accessory slot to lock in-place the slide-in panels. The height of the spring plungers is pre-set at the factory and requires no further adjustment.



Figure 5 (Optional slide-in lenses)

2.5. Control

Studio Force II™ fixture can operate as a stand-alone unit or can be controlled remotely via ANSI E1.11 USITT DMX 512-A protocol. The control function settings can be accessed through the touchscreen LCD display at the rear of the fixture.

Power-up Screen:

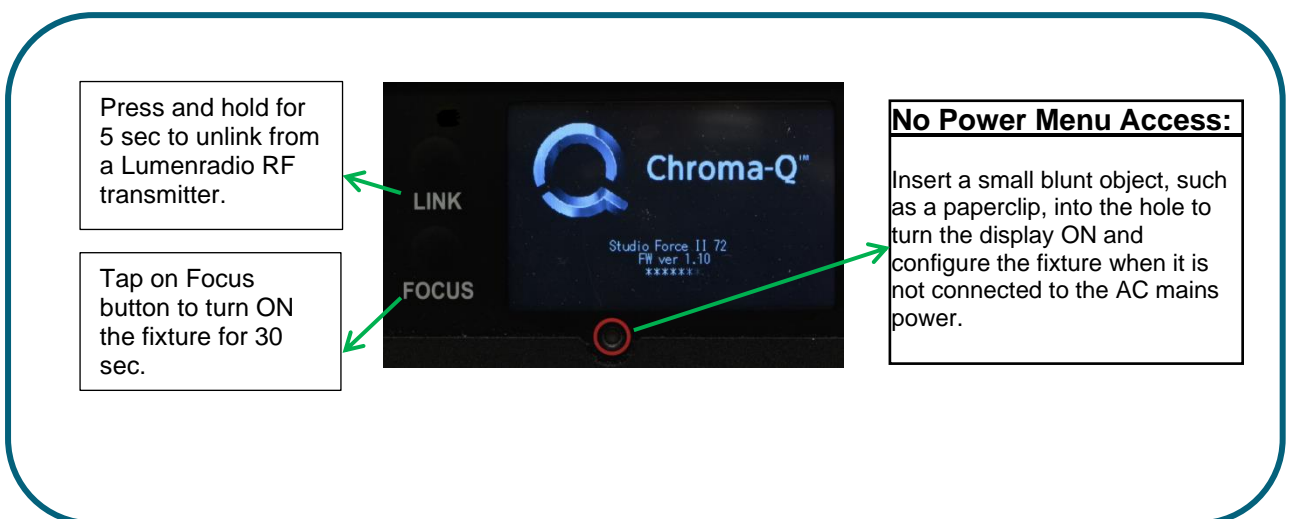

Figure 6 (Start-up Screen)

2.6. Main Menu

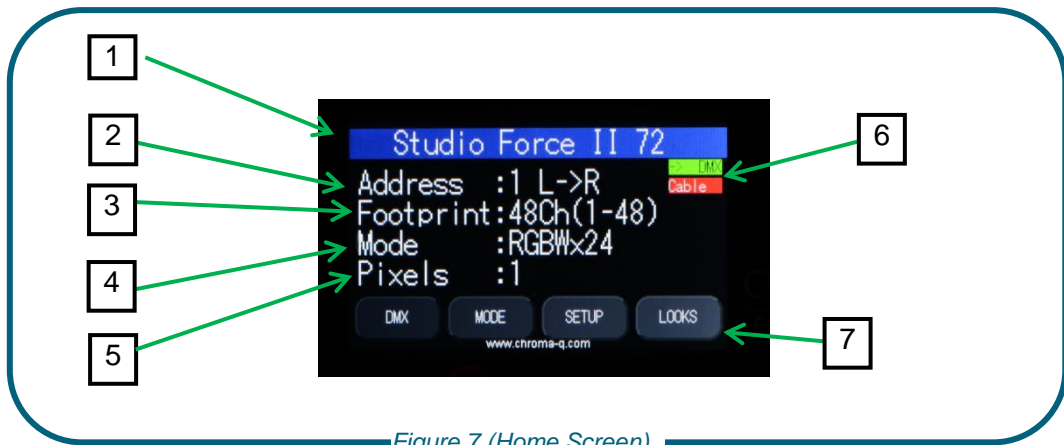

Figure 7 (Home Screen)

Once the unit is powered up, the touch screen LCD display shows the Main Menu with:

1. The model name
2. **Address:** The DMX starting address and orientation
3. **Footprint:** number of DMX slots used in the current configuration
4. **Mode:** current assigned control mode
5. **Pixels:** Current dedicated pixels (or grouping) as per selected grouping & control mode
6. **Data Signal/Source Indicator:** Current input status (DMX cable/DMX wireless/No data cable/No data Wireless)
7. **Configuration option buttons:** Operational and control changes can be made by selecting any of the four configuration option buttons shown in the picture above to access DMX (address), Mode, Setup and preset Looks operation.

L→R shows LED pixels will be controlled beginning at left, going towards right. This can be reversed by choosing R→L in the Mode Menu options.

Note: The “Left” side of the fixture is at power/dmx IN; the “Right” side is at power/dmx out.

The LCD is backlit when the main menu is accessed and will turn off when left undisturbed for 5 seconds.

Data Signal Indicator- Shows the presence and status of DMX signal	
No Data	- appears when the fixture is set at a DMX controllable mode and is not connected to an external DMX source/ console.
>>>DMX	- appears when the fixture is set at a DMX controllable mode and is receiving a DMX signal from an external DMX source/ console.
DMX >>>	-appears when the fixture is set at Master and is outputting a DMX data signal.

Table 4 (Data Signal Indicator)

Configuration option buttons

DMX

The factory default address is 1. The LCD screen displays the current DMX start address and the new DMX start address. In this screen, the numeric command buttons can be tapped, to set the new DMX start address.

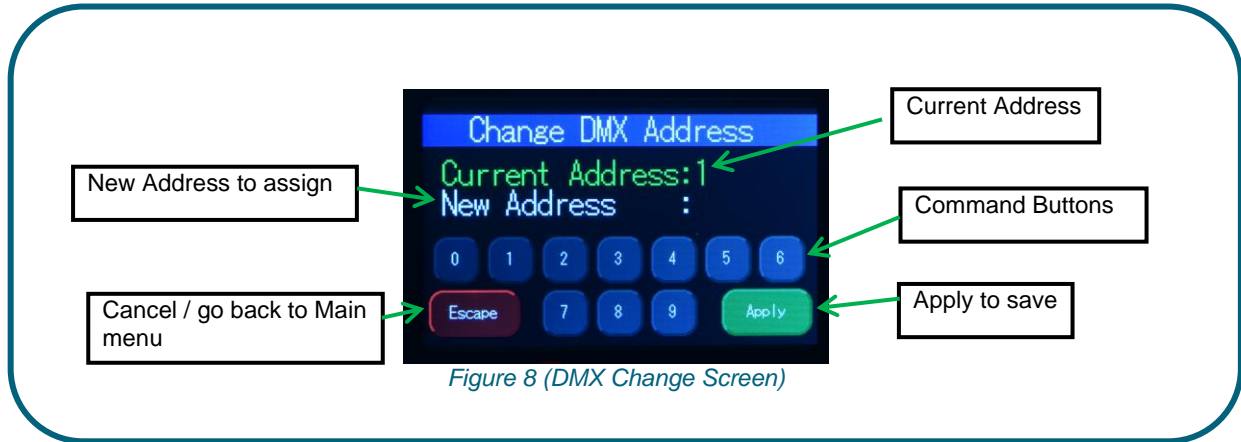

Command Button	Description
0 – 9	Tap in combination, to enter the new DMX start address
Apply	Tap to save the new DMX address.
Escape	Tap to Exit the screen.

Table 5 (DMX Change Command Buttons)

To set/change the DMX start address,

1. Main menu, **tap on** DMX
2. Next screen will be, "Change DMX Address"
3. **Tap on** 0-9 command buttons in combination, to enter the new DMX start address
4. **Tap on** Apply to save
5. Control goes back to the Main menu screen and the new DMX start address will be displayed
6. **Tap on** Escape anytime to cancel

3. Mode

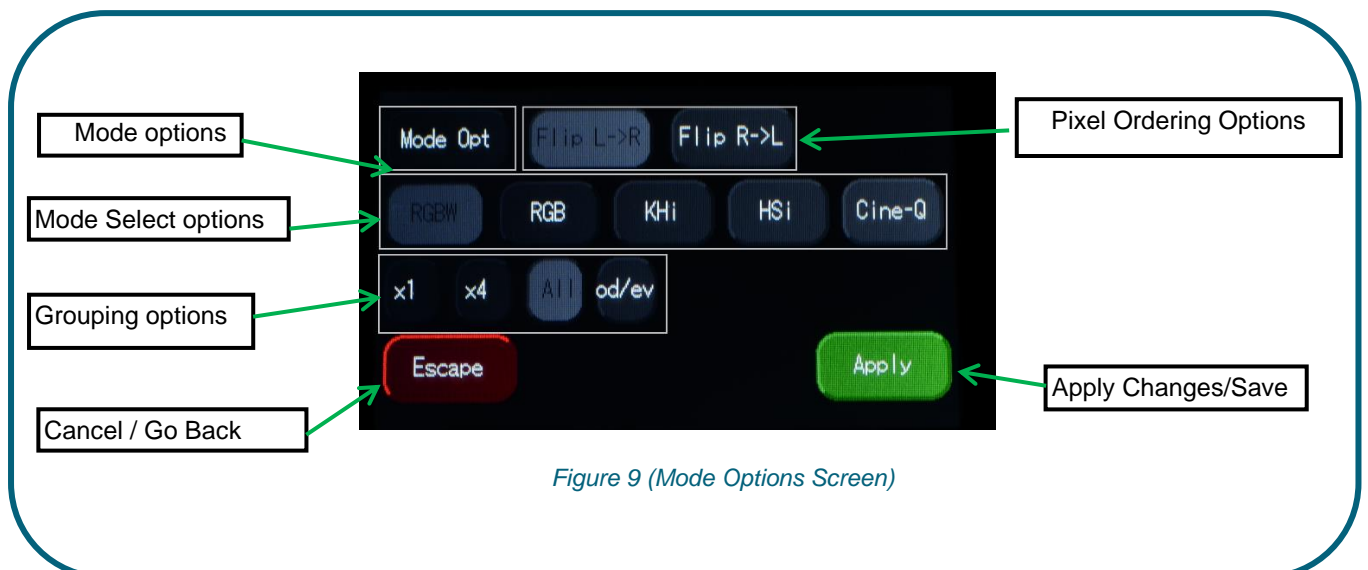

3.1. Mode Select Options

KHi (Kelvin, Hue, and intensity) gives 3 parameter channels to each group; 1 channel for colour temperature and 1 for hue (\pm Green), and third for the intensity. Hue channel when set at 50%, the colour output is at black body curve. Above 50%, it shifts towards green and below 50% it shifts towards red area on the black body curve. A separate definable intensity channel is particularly useful when creating intensity chases or when the grand master is used. Below table shows the CCT output, at different K, H, i settings. The DMX map is shown in Table 19 (DMX Map-KHi).

K	H	i	CCT
0%	50%	100%	≈2800K
12%	50%	100%	≈3200K
50%	50%	100%	≈4400K
75%	50%	100%	≈5600K
100%	50%	100%	≈6500K

Table 6 (KHi-CCT Output)

Cine-Q (Intensity Kelvin, Hue, Red, Green, Blue, White and Crossfade) is a combination of the KHI and RGBW mode, with the ability to crossfade between either mode. It gives 8 or 9 parameter channels to each group; one global intensity, one parameter for colour temperature and one for hue (\pm Green), and then Red, Green, Blue and White parameters. A crossfade parameter allows to fade from KH to RGBW parameters. The default value for Kelvin and Hue parameters should be 50%. The crossfade parameter can be set to 16-bit for a more accurate crossfade when using very long transition. The DMX map is shown in Table 20 (DMX Map-CINE-Q-iKHRGBW).

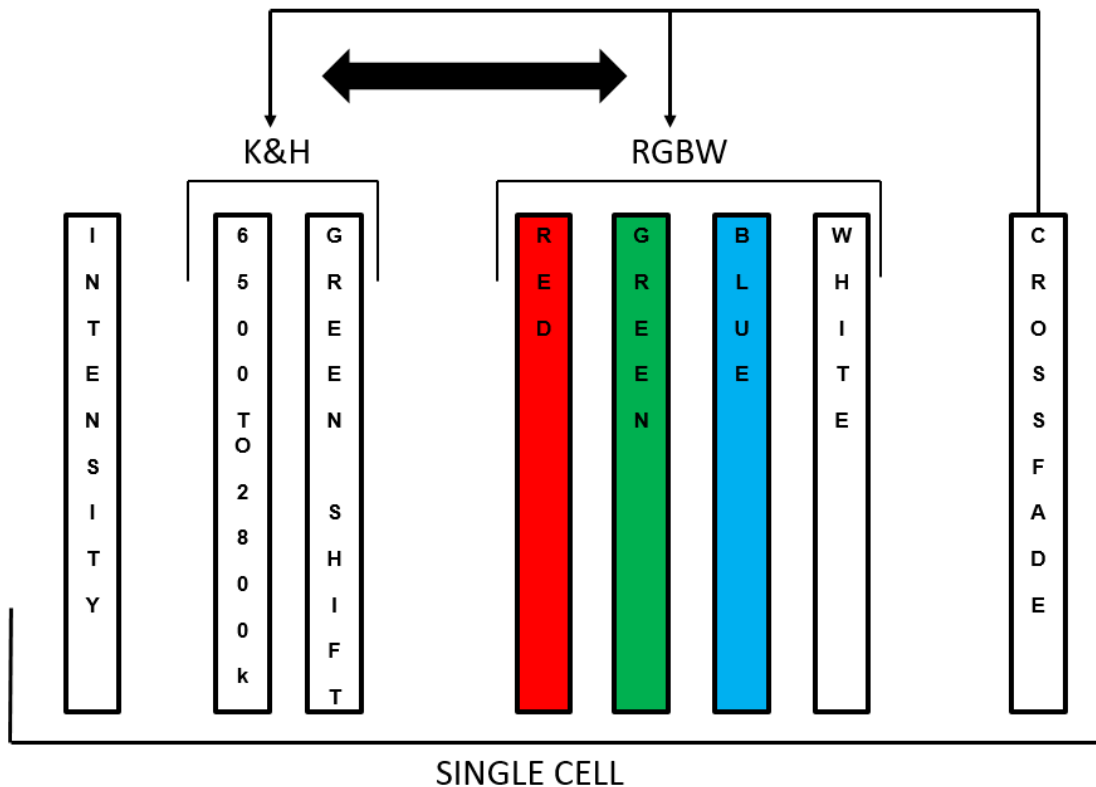

Figure 10 (CINE-Q CROSSFADE)

RGBW (Red, Green, Blue and White): This mode assigns 4 DMX channels to set Red, Green, Blue and White levels in each cell, or group of cells. It provides 4 parameter channels that directly affect the intensity of each color within a group. Color is mixed by adjusting the levels of each of the four channels using an external DMX controller/ console. The DMX footprint will be determined by the selected grouping option. White (of about 3,500K) is achieved with only white channel at full. Refer to the Table 7 (SFII 72 DMX Grouping), Table 8 (SFII 48 DMX Grouping), Table 9 (SFII 12 DMX Grouping), for detail on grouping selection and DMX footprints. The DMX map is shown in Table 16 (DMX Map-RGBW).

To set the fixture to RGBW mode,

1. On the Main Menu, tap Mode
2. On the Mode screen, tap RGBW
3. Tap Apply to save or Escape to cancel

RGB (Red, Green, and Blue) gives 3 parameter channels directly affecting the intensity of the corresponding group. Color is mixed by adjusting the levels of the three primary colors in each group. The DMX footprint will be determined by grouping option selected. The white color is automatically mixed in when all three colour parameters are engaged. The DMX map is shown in Table 17 (DMX Map-RGB).

To set the RGB mode,

1. On the Main Menu, tap Mode
2. On the Mode screen, tap RGB
3. Tap Apply to save or Escape to cancel

HSi (Hue, Saturation and Intensity) gives 3 control channels to each group; 2 channels for hue and saturation and one intensity channel. A separate definable intensity channel is particularly useful when creating intensity chases or when the grand master is used. The hue channel has 255 different colors available and the saturation channel specifies the saturation level of that color. The saturation channel is fully saturated at full. White is achieved with the intensity channel to full and the saturation channel at zero. With this mode enabled, the Hue channel is from Red to Red (R→G→B→R). The DMX map is shown in Table 18 (DMX Map-HSi).

****Extended Control Channel:** An extra Control parameter can be enabled, it will be place as the last parameter of the fixture control mode. The Control channel allows for remotely control certain aspect of the fixture such as the fan speed, PWM frequency and more functions.

3.2. Mode Options



Cine-Q 16b The crossfade parameter can be set to 16-bit for a more accurate crossfade and better granularity, when using very long transition. When set at this mode, one extra channel (#9) is assigned for very small step increase/decrease in the intensity (0.0% to 1.0%) with change in the DMX fader value form 0-255. See Table 21 (DMX Map-CINE-Q-iKRGBW-16bit) for the DMX Map.

Mode	i	K	H	R	G	B	W	X	x
Cine-Q 8b	1	2	3	4	5	6	7	8	--
Cine-Q 16b	1	2	3	4	5	6	7	8	9

****Extended** This setting assigns one extra channel in the end, which allows remote override of certain settings such as engine frequency, fan speed, Dimmer curve and DMX Lost state. This option allows users to temporarily override touch screen menu entered settings, using one extra channel on a DMX console.

To override a current setting in the fixture,

1. Set the value of this channel to the desired setting (DMX Value) listed in the Table 23 (DMX Map-Extended Control Channel).
2. Wait for 5 sec.
3. The fixture will retain that setting, until it is changed again or the fixture is power cycled.
4. To avoid any unintentional settings override, set the extended channel back to DMX value 0.

After the power cycle, the extended control setting will be reset and the fixture will default back to the last settings set by the touch screen display menu or the RDM.

HSi Legacy The option allows the new Studio force fixtures match the HSi pattern, with old Chroma-Q HSi mode enabled fixtures. With Legacy hue mode enabled, the Hue channel is from Blue to Blue (B→G→R→B).

3.3. Grouping Options

Studio Force II™ offers a powerful, wide variety of grouping options for the individual cells (or pixels) within each fixture. Grouping is independent of control mode selection. A Studio Force II™ 72 fixture consists of 24 cells, a Studio Force II™ 48 fixture consists of 16 cells and a Studio Force II™ 12 fixture consists of 4 cells. “Cell” or pixel grouping allows individual control of each single cell or various grouping of cells as defined in the tables below. In “ALL” grouping, all cells in the Studio Force II™ 72/48/12, the fixtures will be controlled as 1 group. In x1 each cell is being controlled independently for a total of 24, 16 or 4 individual cells for the Studio Force II™ 72, 48 or 12 respectively. The number in the table below, indicate the group number.

Od / Ev: Controls every other cell (pixels) in two groups of control – odd cell and even cells.
X4: (48 and 72 models only) Controls cells in group of 4
X1: Each cells are controlled individually

Grouping & DMX Addressing

Grouping: Studio Force II™ 72									Flip: L→R																	
Group Selected	Group Number(s)																									
	All	1	1	1	1	1	1	1	1	1	1	1	1	1	1	1	1	1	1	1	1	1	1	1	1	1
x4	1	1	1	1	2	2	2	2	3	3	3	3	4	4	4	4	5	5	5	5	6	6	6	6		
x1	1	2	3	4	5	6	7	8	9	10	11	12	13	14	15	16	17	18	19	20	21	22	23	24		
Od/Ev	1	2	1	2	1	2	1	2	1	2	1	2	1	2	1	2	1	2	1	2	1	2	1	2	1	2

Table 7 (SFII 72 DMX Grouping)

Grouping: Studio Force II™ 48								Flip: L→R									
Group Selected	Group Number(s)																
	All	1	1	1	1	1	1	1	1	1	1	1	1	1	1	1	1
x4	1	1	1	1	2	2	2	2	3	3	3	3	4	4	4	4	
x1	1	2	3	4	5	6	7	8	9	10	11	12	13	14	15	16	
Od/Ev	1	2	1	2	1	2	1	2	1	2	1	2	1	2	1	2	

Table 8 (SFII 48 DMX Grouping)

Studio Force II™ 12		L→R		
Group Selected	Group Number(s)			
All	1	1	1	1
x1	1	2	3	4
Od/Ev	1	2	1	2

Table 9 (SFII 12 DMX Grouping)

3.4. Pixel ordering Options

The starting DMX address can be selected to be on the right or left of the fixture as indicated on the display. The “Left” side of the fixture is at power/dmx IN; the “Right” side is at power/dmx out. Table #10, is an example of address ordering for a Studio Force II™ 72, with x1 Grouping selected.

L→R	1	2	3	4	5	6	7	8	9	10	11	12	13	14	15	16	17	18	19	20	21	22	23	24
R→L	24	23	22	21	20	19	18	17	16	15	14	13	12	11	10	9	8	7	6	5	4	3	2	1

Table 10 (Flip Grouping)

3.5. DMX Footprints

Number of DMX Channels used in Mode/Grouping Combinations
P.S.: Add one extra channel when Extended mode is enabled

Studio Force II™ 72						
Control Mode	KHi	Cine-Q	Cine-Q 16bit	RGBW	RGB	HSi
Grouping						
All	3	8	9	4	3	3
x4	18	48	54	24	18	18
x1	72	192	216	96	72	72
Od/Ev	6	16	18	8	6	6

Table 11 (SFII 72 Mode-Grouping DMX Values)

Studio Force II™ 48						
Control Mode	KHi	Cine-Q	Cine-Q 16bit	RGBW	RGB	HSi
Grouping						
All	3	8	9	4	3	3
x4	12	32	36	16	12	12
x1	48	128	144	64	48	48
Od/Ev	6	16	18	8	6	6

Table 12 (SFII 48 Mode-Grouping DMX Values)

Studio Force II™ 12						
Control Mode	KHi	Cine-Q	Cine-Q 16bit	RGBW	RGB	HSi
Grouping						
All	3	8	9	4	3	3
x1	12	32	36	16	12	12
Od/Ev	6	16	18	8	6	6

Table 13 (SFII 12 Mode-Grouping DMX Values)

4. Set up Menu

Studio Force II™ technical operation can be changed and viewed using the Setup menu options.

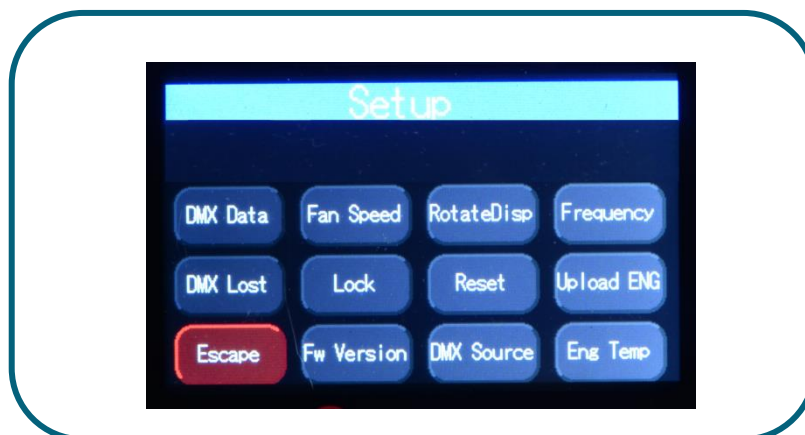

Figure 11 (Setup Menu Screen)

Command	Description
DMX Data	Displays the incoming DMX levels for the assigned channels.
Fan Speed	4 Fan Speed options are accessed through the Fan Speed screen: Quiet – internal fan is off and maximum intensity reduced to 80%. Studio – internal fan is at low speed. Live – internal fan is on. Live-Quiet – internal fan is automatically switched ON when light output is ON and vice-versa.
Rotate Disp	This button rotates the orientation of the Touch Screen Display 180 degrees
Frequency	Frequency options can be viewed and selected. Available options: 750 Hz, 1500 Hz, 3000Hz, 6000 Hz, 12000Hz, 24000Hz.
DMX Lost	The fixture can be set with 3 options when DMX data is lost: Last data – holds the last valid DMX state No Output – the fixture switches to off Look – select a prerecorded Look to execute
Lock	The touch screen LCD can be set to lock or unlock in the Lock feature screen.
Reset	Reset Settings options are accessed through the Reset Setting screen: Default – Factory default settings User – User defined settings
Upload ENG	The fixture can be set for light engine software upload/ upgrade through this screen.
FW Version	Displays current software version.
DMX Source	Displays current DMX source – cable or wireless
Eng Temp	Displays LIVE value for temperature of all the engines in fixture.
Escape	Exit the screen

Table 14 (Setup Menu Options)

4.1. DMX Data

This option allows user to see the DMX channel intensity levels, being received by the fixture. This DMX channel entered will be formatted and displayed on this screen, based on selected mode and grouping. The values read from 0 to 99 (as 0%- 100% intensity).



Figure 12 (DMX Data Screen)

To show DMX Data,

1. On the Main Menu, tap SETUP
2. Then tap DMX Data
3. The display shows the DMX start channel and the values (0-99) of the DMX channels
4. Tap Escape to go to back

4.2. Fan Speed

The internal fan of the fixture can be set to four speed options to regulate noise levels and the cooling process.



Figure 13 (Fan Mode Select Screen)

Quiet	The internal fans are off and light output is reduced by 20%.
Studio	The fan speed is at low velocity and light output is at 100%.
Live	The fan speed is at high velocity and the light output at 100%
Live-Quiet	Internal fans are turned off when all DMX values are at 0%.

Note: Studio Force II™ unit is internally temperature protected at all times.

To set the Fan Speed Mode,

1. On the Main Menu, tap Setup
2. Then tap Fan Speed option
3. On the Fan Speed screen, select a Fan Speed option, and then tap Apply to save

4.3. Rotate Display

Display screen menu can be rotated 180° (upside down) by tapping on this button.

To set the orientation of the display,

1. On the Main Menu screen, tap Setup Menu.
2. On the Screen Setup screen, tap RotateDisp
3. The display screen rotates by 180 degrees

4.4. PWM Frequency

The Studio Force II has following frequency settings available: 750 Hz, 1500 Hz, 3000Hz, 6000 Hz, 12000Hz, 24000Hz. This allows for the LED scan rate to be synchronized with the video camera and avoid a flickering effect.

Trade-off: Better dimming is achieved at lower frequencies; flickering effect is minimized at higher PWM frequencies.



Figure 14 (PWM Select Screen)

To set the Frequency,

1. On the Main Menu, tap Setup Menu
2. On the Setup screen, tap Frequency
3. On the Frequency screen, select and tap a Frequency option, then tap Apply to save

4.5. DMX Lost

If DMX is not detected various output options can be selected in this mode:

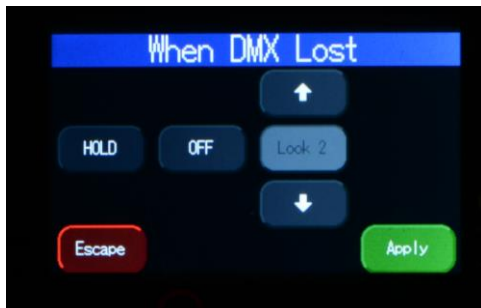

Figure 15 (DMX Lost Mode Select Screen)

OFF	will snap to off after 5 seconds
Hold	will hold the last valid DMX state
Look 1-31	will snap to the user saved look

To set DMX Lost action;

1. On the Main Menu, tap Setup Menu
2. On the Setup screen, tap DMX Lost
3. On the When DMX Lost screen, select and tap an output option, then tap Apply to save

Note: If a Look is selected for playback when DMX is lost, the unit will playback the selected look on power up, as long as DMX is not present.

4.6. Lock feature

Factory default sets the display screen to turn off and lock when untapped for 30 seconds. A lock symbol appears on the screen, when tapped. This feature provides protection against accidental user input.

To disable or enable the lock,

1. On the Main Menu, tap Setup Menu
2. On the Setup screen, tap Lock button.
3. On the Lock Feature screen, tap Enable or Disable, then tap Apply to save

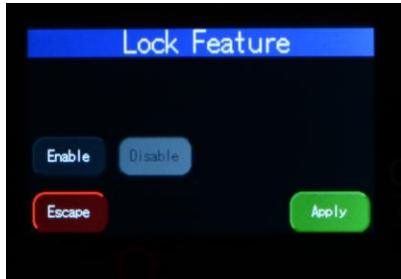

Figure 16 (Lock Feature Select Screen)

If the Lock feature is enabled, touch and hold the lock icon for 5 seconds to unlock.



Figure 17 (Lock Feature Select Icon)

Display Lock Icon
Note: The Lock Icon turns green when pressed and held for 5 sec to unlock

4.7. Reset and Factory Defaults

In this menu,

- Current user settings can be saved.
- The fixture can be reset to the save user settings.
- The fixture can be reset to the factory default settings. All recorded Looks are erased.

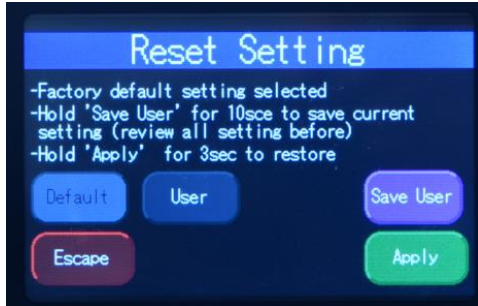

Figure 18(Reset Settings Screen)

To save the current user settings,

1. Review all settings
2. On the Main Menu, tap Setup Menu
3. On the Setup screen, tap Reset
4. On the Reset Setting screen, press and hold

“Save User” for 5 seconds to save the current settings.

(Follow the text prompt that appears on the screen)

To reset the fixture to the save user settings,

1. On the Main Menu, tap Setup Menu
2. On the Setup screen, tap Reset
3. On the Reset Setting screen, tap User
4. Press and hold Apply for 3 seconds to restore the saved user settings

To reset the fixture to the factory default settings,

1. On the Main Menu, tap Setup Menu
2. On the Setup screen, tap Reset
3. On the Reset Setting screen, tap Default
4. Press and hold Apply for 3 seconds to restore the factory default settings

DMX Address	1
Foot Print	3ch (1-3)
Mode	KHI
Lock	Disabled
Pixels	All
DMX Lost	Last data (HOLD)
Fan Speed	Live
Frequency	750Hz
Reset	Default
Flip	L→R
Cine-Q 8b	Enabled

Table 15 (Factory Default Settings)

4.8. Upload Engine

RECOMMENDED ONLY FOR FACTORY TRAINED PERSONNEL.

LED Engine software can be uploaded to the fixture from the Chroma-Q Uploader II by accessing this menu.

Refer to the Quick Start Guide of the Chroma-Q Uploader II.

Link: http://www.chroma-q.com/support/quick-start/CHUSBLOADERII_Uploader-quickstartguide.pdf

Software for the LED engines must be uploaded to the Studio Force II™ using the Chroma-Q Uploader II:

1. In "Setup", select "Upload Engines" then press Enter, and the display shows "Ready"
2. Connect an XLR 5-pin cable from the Uploader to the individual Studio force II unit
3. Power-up the Uploader - display shows the file name, and "Ready"
4. Press the "ERASE TARGET" button once to clear the target firmware
5. Press the "Start Uploading" button once to execute the uploading
6. An animated progress is displayed on the Uploader and CF unit indicating the upload process
7. "UPLOADING DONE" appears on the Uploader upon completion of a successful upload and the target device resets to the Main Menu
8. Power-cycle the unit

Note: The Chroma-Q Uploader II must be purchased separately.

4.9. FW Version

This screen displays current software version of fixture at the address header. For added versatility, Individual firmware versions of all the engines are also displayed.

4.10. DMX Source

This enables the input connection.



Figure 19 (DMX Source Select Screen)

INPUT	DMX from console via cable
WIRELESS	Lumen Radio input

Select the DMX source and press Apply.

4.11. Engine Temp

Tap on this to see individual temperature in °Celsius of each engine in the fixture. Each LED engine drives two cells on the Studio Force II™.



Figure 20 (Light Engine Temp Screen)

5. Look Store

Looks can be recorded to the internal flash memory by users and will be preserved on power down. However, looks will be returned to default setting if Default Reset is performed.

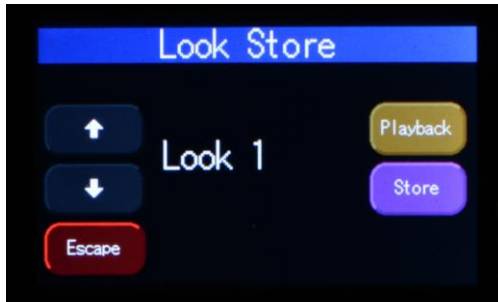

Figure 21 (Look Selection Screen)

1. Set the Studio Force II™ to the desired color and intensity using a DMX console.
2. Go to the Look Store screen as shown above and select the Look number where the Look will be stored.
3. Press Store for 2 seconds to save the Look.
4. "Look Stored" will be displayed on the screen to confirm.
5. Multiple looks can be saved from Look (1-31).
6. Playback button allows the user to check what look is at (1-31).

6. Thermal Performance

The Studio Force II™ 12, 48 & 72 feature in-built fans that control the internal temperature of the fixture. If the internal temperature of the Studio Force exceeds 75°C the output of the fixture will be reduced as an automatic protection feature. This may happen when the ambient temperature is over 40°C or the internal fans are blocked or damaged due to mishandling of the fixture. The airflow to and from the fan must not be constricted to maintain the maximum light output of the Studio Force II™.

7. Troubleshooting

Troubleshooting is a process of elimination. First, rule out the other field factors (i.e. bad connections, faulty cables and power supplies). For technical support and/or parts, please contact nearest Chroma-Q dealer.

Symptom	Possible Cause	Solution
Fixture does not respond to DMX control.	<ol style="list-style-type: none"> 1. Set to wrong or different DMX address. 2. Bad cable connecting DMX control and fixture. Bad in/through connection between adjacent fixtures. 3. Console patch is incorrect. 	<ol style="list-style-type: none"> 1. Check DMX address and Mode settings. 2. Check/replace DMX run from the console. 3. Check DMX values in the Setup/DMX Data screen as described above to verify the fixture is “seeing” the DMX data.
Noise from fixture unit.	Fan malfunction.	Check fan.
Low LED output.	Internal temperature is over the limit. Fan is not working.	<ul style="list-style-type: none"> • Verify Engine temperature using the Setup/ Eng Temp screen. • Check “Fan Control” mode. Check fan. • Check for airflow - to and from the internal fan. • Check area ventilation.

8. Maintenance

With care, the Studio Force™ II will require little or no maintenance. However, as the unit is likely to be used in a stage environment, we recommend periodical inspection and cleaning of any resulting dust on the unit.

Do not spray liquids on the front or rear panel. Do not use solvents to clean the fixture. If the front enclosure requires cleaning, wipe with a mild detergent on a damp cloth.

9. Specification

9.1. Technical specifications

	Studio Force II V72	Studio Force II V48	Studio Force II V12
Product	CHSF2V72	CHSF2V48	CHSF2V12
Dimensions:	1759mm x 182mm x 177mm 69.25" x 7.25" x 7"	1,181mm x 165mm x 191mm / 46.5" x 6.5" x 7.5"	335mm x 190mm x 218mm / 13.2" x 7.5" x 8.6"
Weight:	24kg / 53lbs	18 Kg / 40lbs	5 Kg / 11lbs
Power input	100-240VAC, 800VA, 50-60Hz	100-240VAC, 550VA, 50-60Hz	100-240VAC, 160VA, 50-60Hz
Power	Neutrik powerConTRUE1		
Data	Neutrik XLR 5-pin		
Control	ANSI E1.11 USITT DMX 512-A		
Cooling	Forced - 2 fans	Forced - 2 fans	Forced - 1 fan
Construction:	Anodized aluminum extrusion		
Color:	RAL 9005/ Black, RAL 9016/ White		
LED Pixels:	24	16	4
Optics:	Specialized close focus lens		
Beam angle:	~ 22° (approx.)		
Beam	Symmetrical direct illumination		
CCT:	Adjustable 1000 – 10000K (fully calibrated between 2800K and 6500K)		
CRI:	Up to 94		
Lamp Life:	Up to 50,000 hours		
IP Rating:	IP20		
Operating	0°C to 40°C		
Approvals:	CISPR 22:2006/EN55022:2006 & CISPR 24:1997/EN55024:1998 ICES-003:2004 & FCC Part 15 Subpart B:2007 CSA C22. No. 166-M1983:R2008 UL 1573:2003; UL 8750		



9.2. Technical Drawings

Studio Force II 72

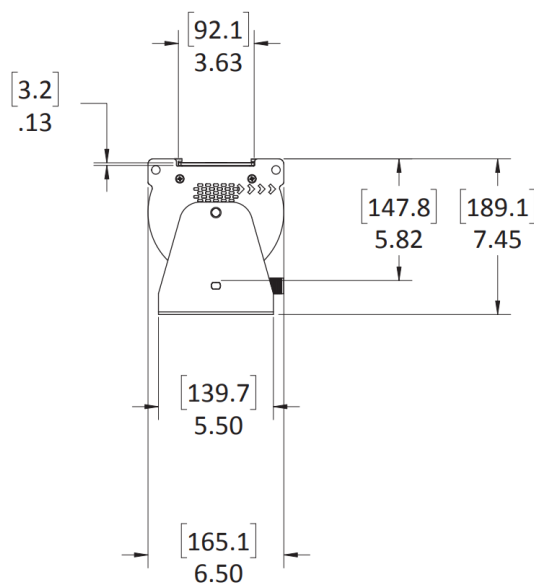
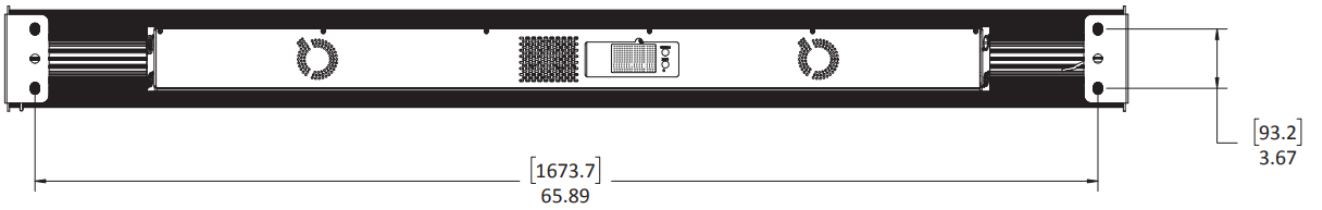
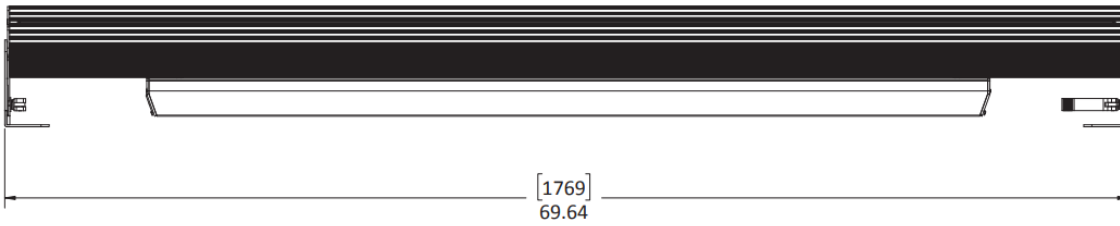
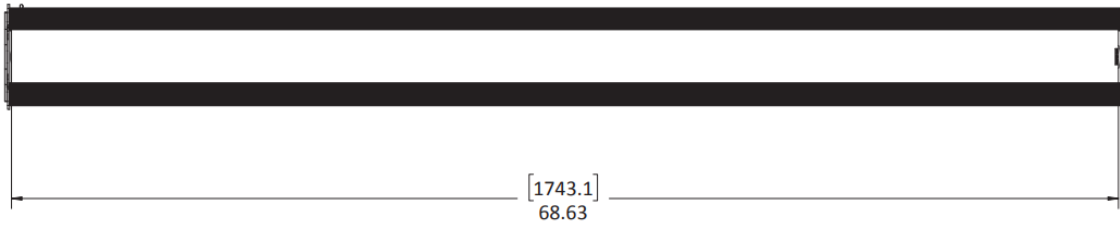

Studio Force II 48

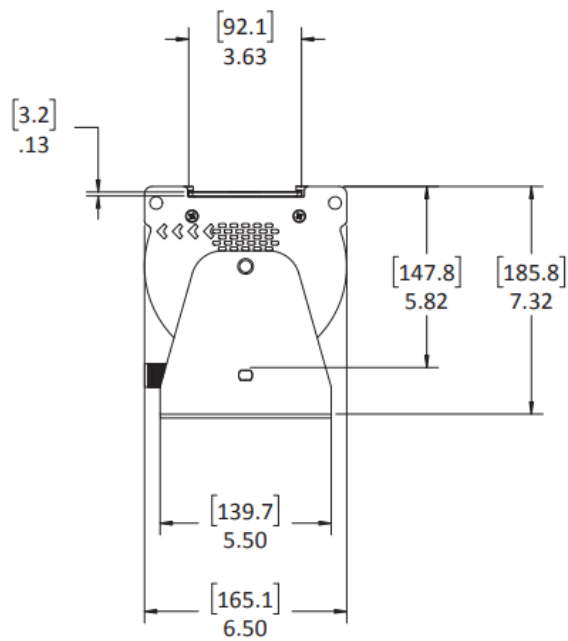
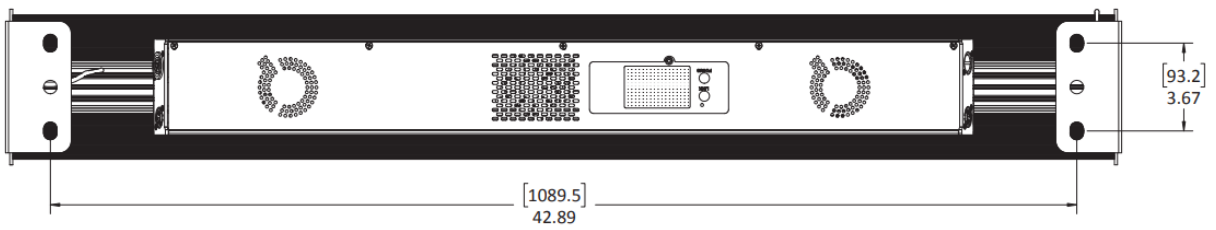
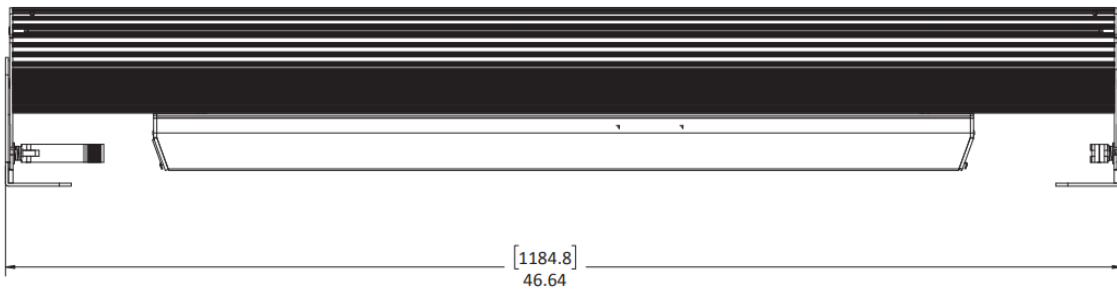
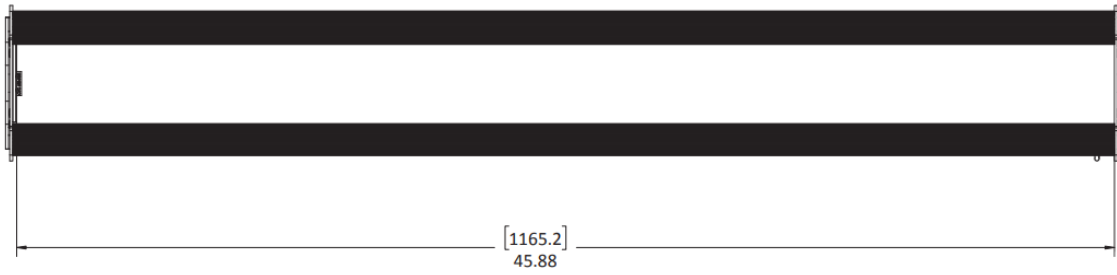

Studio Force II 12

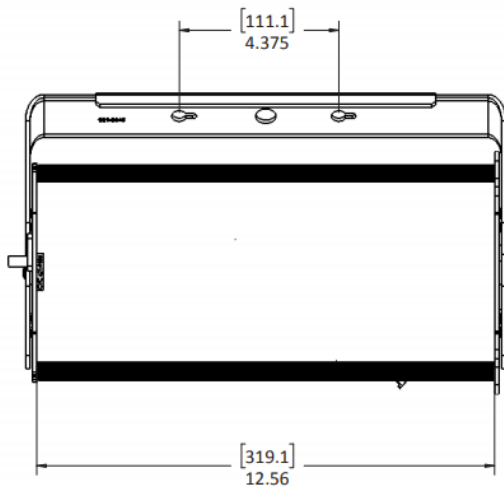
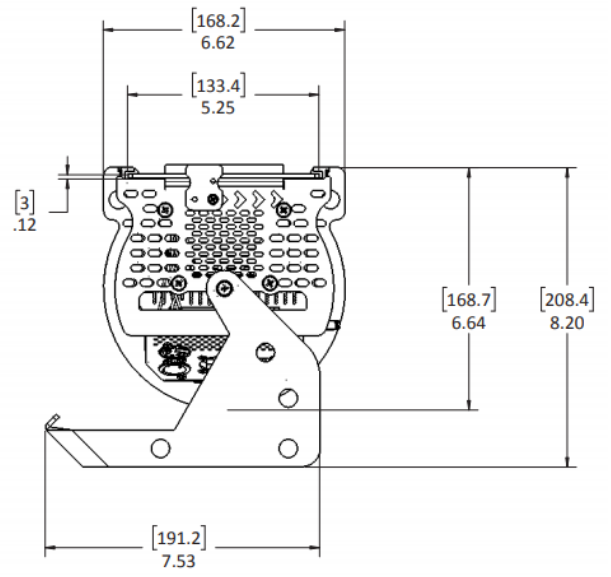
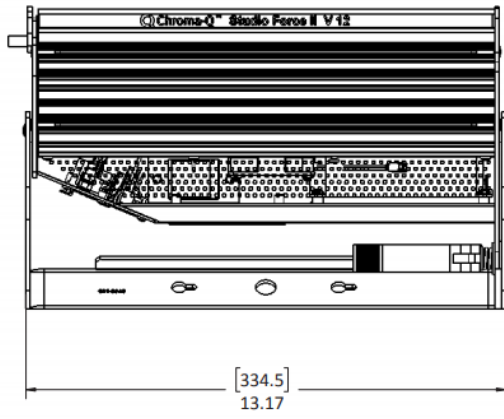

10.Menu Tree

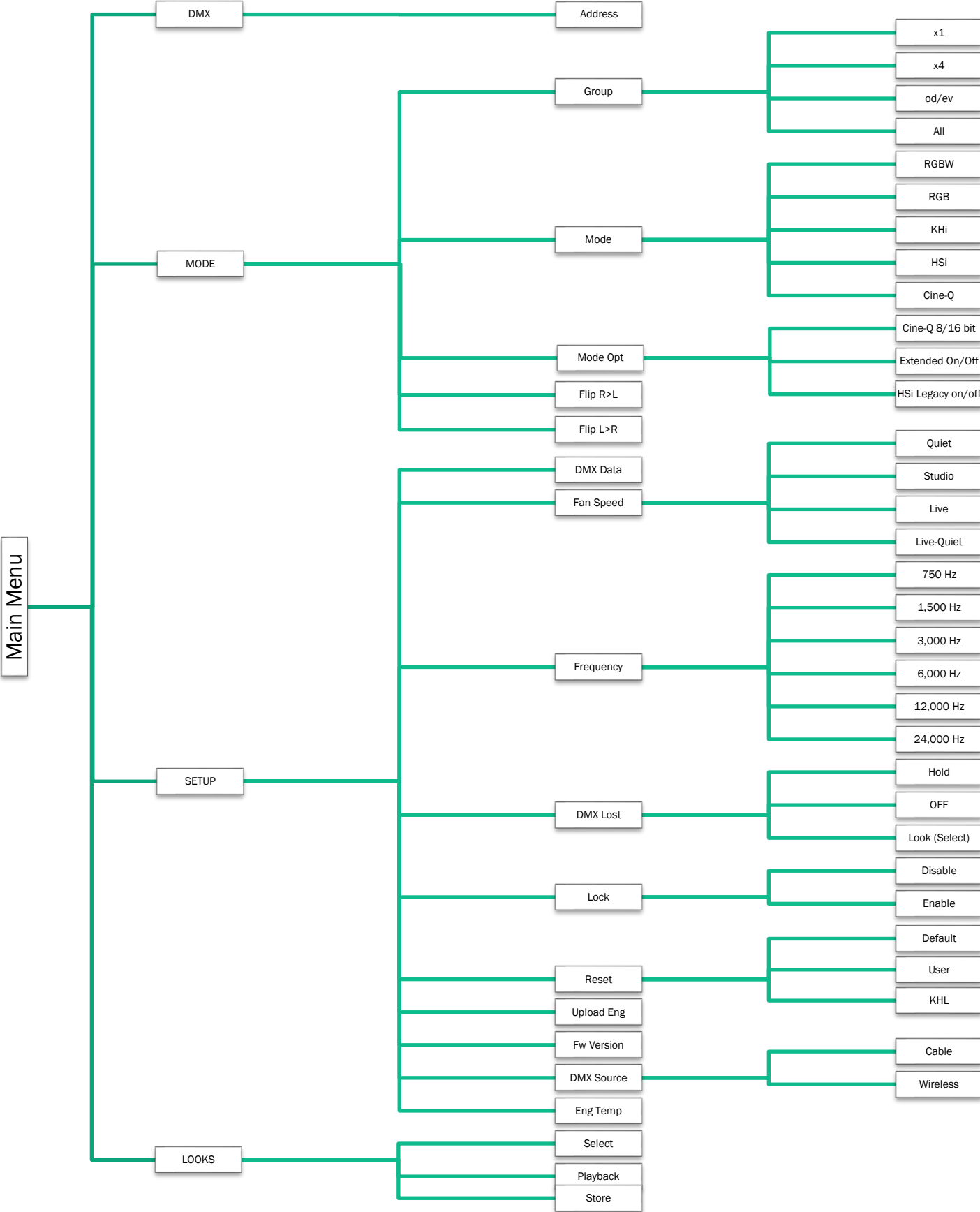

11.DMX Map

11.1. Studio Force II DMX map for RGBW Control Mode:

Table 16 (DMX Map-*RGBW*)

RGBW	Value	Function	Fade Status	Default Value
1		Red		
	0 - 255	Minimum → Maximum Intensity	Fade	0
2		Green		
	0 - 255	Minimum → Maximum Intensity	Fade	0
3		Blue		
	0 - 255	Minimum → Maximum Intensity	Fade	0
4		White		
	0 - 255	Minimum → Maximum Intensity	Fade	0
5**		Extended Controls		
	0 - 255	See Control channel table for details	Snap	0

Channel 1 through 4 will repeat for each cell control according to the selected grouping mode
 ** Control parameter is only present when Extended mode is enabled
 Control parameter is always last, its position will change according the grouping mode.
 For example, in odd/even grouping mode, the control parameter would be on 9

11.2. Studio Force II DMX map for RGB Control Mode:

Table 17 (DMX Map-*RGB*)

RGB	Value	Function	Fade Status	Default Value
1		Red		
	0 - 255	Minimum → Maximum Intensity	Fade	0
2		Green		
	0 - 255	Minimum → Maximum Intensity	Fade	0
3		Blue		
	0 - 255	Minimum → Maximum Intensity	Fade	0
4**		Extended Controls		
	0 - 255	See Control channel table for details	Snap	0

Note: Channel 1 through 3 will repeat for each cell control according to the selected grouping mode
 ** Control parameter is only present when Extended mode is enabled
 Control parameter is always last, its position will change according the grouping mode.
 For example, in odd/even grouping mode, the control parameter would be on 7

11.3. Studio Force II DMX map for HSi Control Mode:

Table 18 (DMX Map-HSi)

HSi	Value	Function	Fade Status	Default Value
1		Hue*		
	0 - 255	Color Spectrum 0 → 360 Red → Red	Fade	0
2		Saturation		
	0 - 255	Desaturated → Saturated	Fade	0
3		Intensity		
	0 - 255	Minimum → Maximum Intensity	Fade	0
4**		Extended Controls		
	0 - 255	See Control channel table for details	Snap	0

Note: Channel 1 through 3 will repeat for each cell control according to the selected grouping mode

* With Legacy hue mode enabled, the Hue channel is from Blue to Blue

** Control parameter is only present when Extended mode is enabled

Control parameter is always last, its position will change according the grouping mode.

For example, in odd/even grouping mode, the control parameter would be on 7

11.4. Studio Force II DMX map for KHi Control Mode:

Table 19 (DMX Map-KHi)

KHi	Value	Function	Fade Status	Default Value
1		Kelvin		
	0 - 255 0 64 128 192 255	Warm → Cold 2800K 3200K 4400K 5600K 6500K	Fade	128
2		Hue		
	0 - 255	Minus Green → Plus Green	Fade	128
3		Intensity		
	0 - 255	Minimum → Maximum Intensity	Fade	0
4**		Extended Controls		
	0 - 255	* See Control channel table for details	Snap	0

Note: Channel 1 through 3 will repeat for each cell control according to the selected grouping mode

** Control parameter is only present when Extended mode is enabled

Control parameter is always last, its position will change according the grouping mode.

For example, in odd/even grouping mode, the control parameter would be on 7

11.5. Studio Force II DMX map for Cine-Q i-KH-RGBW Control Mode

Table 20 (DMX Map-CINE-Q-iKHRGBW)

Cine-Q i-KH- RGBW	Value	Function	Fade Status	Default Value
1		Intensity		
	0 - 255	Minimum → Maximum Intensity	Fade	0
2		Kelvin		
	0 - 255	Warm → Cold	Fade	128
	0	2800K		
	64	3200K		
	128	4400K		
	192	5600K		
255	6500K			
3		Hue (Tint)		
	0 - 255	Minus Green → Plus Green	Fade	128
4		Red		
	0 - 255	Minimum → Maximum Intensity	Fade	0
5		Green		
	0 - 255	Minimum → Maximum Intensity	Fade	0
6		Blue		
	0 - 255	Minimum → Maximum Intensity	Fade	0
7		White		
	0 - 255	Minimum → Maximum Intensity	Fade	0
8		Q-Fade		
	0 - 255	KH → RGBW	Fade	0
9**		Extended Controls		
	0 - 255	* See Control channel table for details	Snap	0

Note: Channel 1 through 8 will repeat for each cell control according to the selected grouping mode

** Control parameter is only present when Extended mode is enabled

Control parameter is always last, its position will change according the grouping mode.

For example, in odd/even grouping mode, the control parameter would be on 17

11.6. Studio Force II DMX map for Cine-Q i-KH-RGBW 16bit Control Mode

Table 21 (DMX Map-CINE-Q-iKHRGBW-16bit)

Cine-Q i-KH- RGBW 16bit	Value	Function	Fade Status	Default Value
1		Intensity		
	0 - 255	Minimum → Maximum Intensity	Fade	0
2		Kelvin		
	0 - 255	Warm → Cold	Fade	128
	0	2800K		
	64	3200K		
	128	4400K		
192	5600K			
255	6500K			
3		Hue (Tint)		
	0 - 255	Minus Green → Plus Green	Fade	128
4		Red		
	0 - 255	Minimum → Maximum Intensity	Fade	0
5		Green		
	0 - 255	Minimum → Maximum Intensity	Fade	0
6		Blue		
	0 - 255	Minimum → Maximum Intensity	Fade	0
7		White		
	0 - 255	Minimum → Maximum Intensity	Fade	0
8	0 - 65535	Q-Fade (msb)	Fade	0
		KH → RGBW		
9		Q-Fade (lsb)		
		KH → RGBW		
10**		Extended Controls		
	0 - 255	* See Control channel table for details	Snap	0

Note: Channel 1 through 9 will repeat for each cell control according to the selected grouping mode

** Control parameter is only present when Extended mode is enabled

Control parameter is always last, its position will change according the grouping mode.

For example, in odd/even grouping mode, the control parameter would be on 19

11.7. Studio Force II DMX map group modes

Table 22 (DMX Map-Grouping Modes)

Grouping mode	Description	Number of individual cells control		
		Studio Force II 12	Studio Force II 48	Studio Force II 72
All	Entire fixture as one	1	1	1
X4	Group by 4 cells	1	4	6
Odd/Even	Fixture is alternating cells	2	2	2
Single	Individual cell control	4	16	24

11.8. Studio Force II DMX map Control channel

Table 23 (DMX Map- Extended Control Channel)

Function name	Default	From	To	Description
Control channel				
No Function		0	2	
Reserved		3	40	Reserved for future feature
Fan Speed Off (if possible)		41	42	Fan will never start, fixture output can be reduced or limited
Fan Speed Low		43	44	Slow fan speed (fixture output can be reduced or limited)
Fixed fan speed = full		45	46	Maximum speed on fan
Fixed fan speed = full, regulated light output intensity	X	47	48	Maximum speed on fan but only when needed
Reserved		49	70	Reserved for future feature
PWM 750		71	72	Set PMW rate
PWM 1500		73	74	Set PMW rate
PWM 3000		75	76	Set PMW rate
PWM 6000	X	77	78	Set PMW rate
PWM 12000		79	80	Set PMW rate
PWM 24000		81	82	Set PMW rate
Reserved		83	150	Reserved for future feature
DMX Lost default Fixture stay to the last state	X	151	152	
DMX Lost default Fixture goes black		153	154	
Reserved		155	156	Reserved for future feature
DMX Lost default fixture to selected look		157	158	
Reserved		159	248	Reserved for future feature
No Function		249	255	

Values must be held for 5 second before its function is activated

12. RDM FUNCTIONS

Studio Force II RDM Supported parameters are:

DEVICE_INFO	DMX_PERSONALITY_DESCRIPTION
IDENTIFY_DEVICE	DEVICE_MODEL_DESCRIPTION
DMX_START_ADDRESS	MANUFACTURER_LABEL
SOFTWARE_VERSION_LABEL	DEVICE_LABEL
DEVICE_LABEL	SENSOR_DEFINITION
SENSOR_DEFINITION	SENSOR_VALUE
PARAMETER_DESCRIPTION	REST_DEVICE
DMX_PERSONALITY	

12.1. FREQUENCY, FAN_SPEED and GROUPING

RDM Values for Frequency are as follows

Byte Value	Frequency
0x01	750Hz
0x02	1500Hz
0x03	300Hz
0x04	6000Hz
0x05	12000Hz
0x06	24000Hz

RDM Values for Fan Speed Modes are as follows

Byte Value	Fan Speed
0x01	Quiet
0x02	Studio
0x03	Live
0x04	Live-Quiet

RDM Values for Grouping are as follows

Byte Value	Grouping
0x01	X1
0x02	X2
0x03	X4
0x04	Od/Ev