

Description: User Manual for the complete LumiNode series.
REVISION: 20200618-REV 2.2.1

Luminex
NETWORK INTELLIGENCE

LumiNode USER MANUAL



LUMINODE PRODUCT FAMILY

LumiNode 1 / LumiNode 2 / LumiNode 4 / LumiNode 12

THANKS FOR CHOOSING LUMINEX

MADE IN BELGIUM



TABLE OF CONTENTS

| | | | |
|--|-----------|--|-----------|
| 1. INSTALLATION..... | 4 | 4. LCD DISPLAY | 18 |
| 1.1 Mounting the device | 4 | 5. WEB API | 20 |
| Rack mount..... | 4 | 6. LumiNode IN DETAIL..... | 21 |
| Rack mount - two devices..... | 4 | 6.1 What is a Process engine? | 21 |
| Truss Mount – LumiNode 4..... | 5 | INPUT | 22 |
| Truss Mount – LumiNode 2..... | 6 | DMX..... | 22 |
| Wall Mount – LumiNode 2 | 6 | ArtNet..... | 22 |
| 1.2 Power up the device | 7 | sACN..... | 22 |
| 1.3 Connection..... | 8 | RTTrPL..... | 22 |
| Connection to the network..... | 8 | Internal..... | 23 |
| Connection to the USB port..... | 8 | Play | 23 |
| 1.4 LED indicators..... | 8 | OUTPUT | 23 |
| 1.5 Connection to the web interface | 8 | DMX..... | 23 |
| 1.6 Reset | 8 | ArtNet..... | 23 |
| 2. CONFIGURATION | 9 | sACN..... | 23 |
| 2.1 Web Interface Presentation | 9 | Mode definition..... | 24 |
| Node page..... | 9 | FORWARD | 24 |
| How to reset a process engine | 10 | LTP MERGE | 24 |
| How to configure a Process engine..... | 10 | HTP MERGE..... | 24 |
| DMX / RDM page | 11 | BACKUP..... | 24 |
| Port Settings..... | 11 | X-FADE..... | 24 |
| DMX Settings..... | 11 | SWITCH | 25 |
| DMX Redundancy..... | 12 | CUSTOM..... | 25 |
| Play page | 13 | PATCH OPTION | 26 |
| Show | 13 | MASTER OPTION | 26 |
| Record Trigger..... | 13 | Master / Limit explained | 27 |
| Toolbox page | 14 | 7. CREDITS | 27 |
| Profile Manager | 14 | | |
| Firmware..... | 15 | | |
| Reset..... | 15 | | |
| 3. GLOBAL SETTINGS | 16 | | |
| Control Source | 16 | | |
| IP Settings | 16 | | |
| Device Settings..... | 16 | | |
| Contact Closure..... | 16 | | |
| Miscellaneous..... | 17 | | |

**LUMINODE,
BUILT FOR TODAY,
DESIGNED FOR
TOMORROW**

1. INSTALLATION

1.1 Mounting the device

Depending on the model of the device there are different mounting options:

LumiNode 4 is a device that can be mounted in a truss as well as in a rack. Please read the following instructions to make sure the device is mounted and secured correctly.

■ RACK MOUNT - LumiNode 4

In case you want to mount your LumiNode 4 in a standard 19-inch rack, you must attach the included mounting ears. Connect the longest ear (A) to the right-hand side of the device with 4 screws,

re-used from the device. Attach the shorter ear (B) to the left-hand side again with the 4 screws.

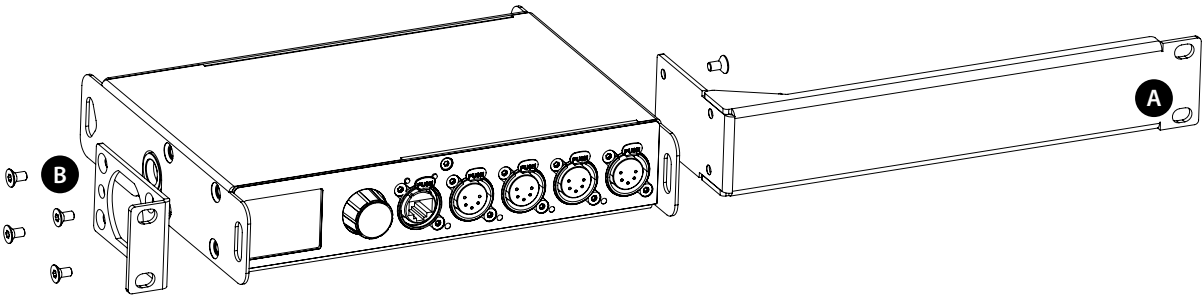

■ RACK MOUNT - TWO DEVICES

In case you want to mount two LumiNode 4 devices or a LumiNode 4 and a LumiCore in a standard 19-inch rack you can mount the two devices together. A space saving way as the two devices will only consume a single row in your 19-inch rack.

First you attach the shortest mounting ears. Connect the shortest ear (C) to the left-hand side of the first device with 4 screws, re-used from the device. Attach the other shortest ear (D),

delivered with the second device, to the right-hand side of the second device, again with 4 screws. Use a pair of mounting brackets (E) to connect the two devices in the middle on the frontside. Use a second pair of mounting brackets (E), delivered with the second device, to connect the devices at the rear. Each pair of brackets must be mounted with 2 screws.

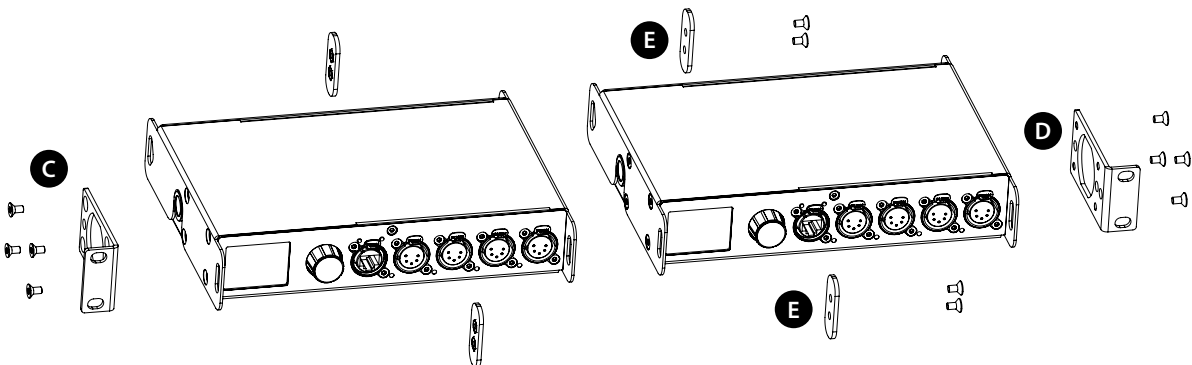

To combine a LumiNode 4 device with a Luminex half 19" device, style GigaCore 10, the mounting procedure differs a little. The bolt (F), not included, replaces the rear couplers at the rear side of the device. Use the correct bolt, M10x20, with a screw wire no longer as 20mm. You can order this part from Luminex (Part Number: R 90 01042)

Screw the bolt, through the LumiNode 4 back ear, into the side M10 insert and tighten it. The rest of the mounting procedure remains the same.

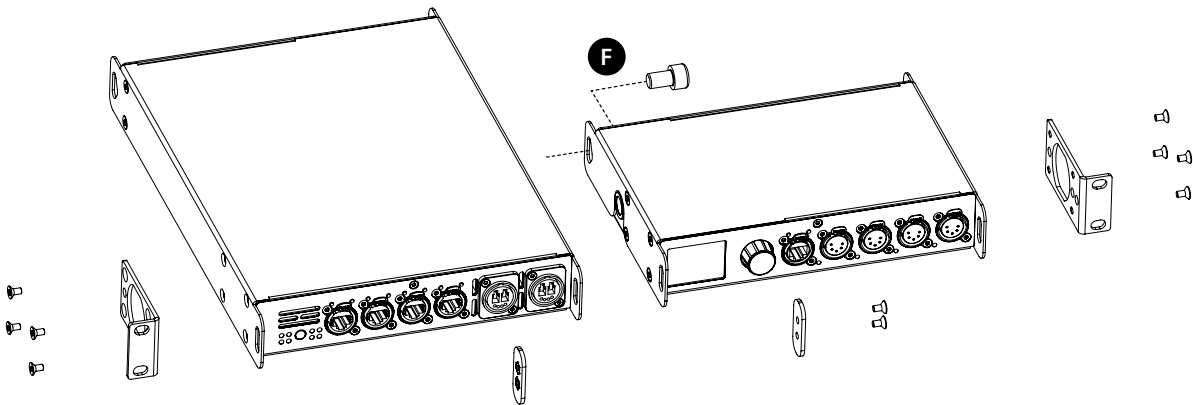

■ TRUSS MOUNT – LumiNode 4

To mount a LumiNode 4 in a truss, you must attach a M10 clamp (G) to the M10 insert (H). After that, you can mount the clamp to

the truss bars. Please also secure the device by attaching a safety line directly to the truss bars as well (I).

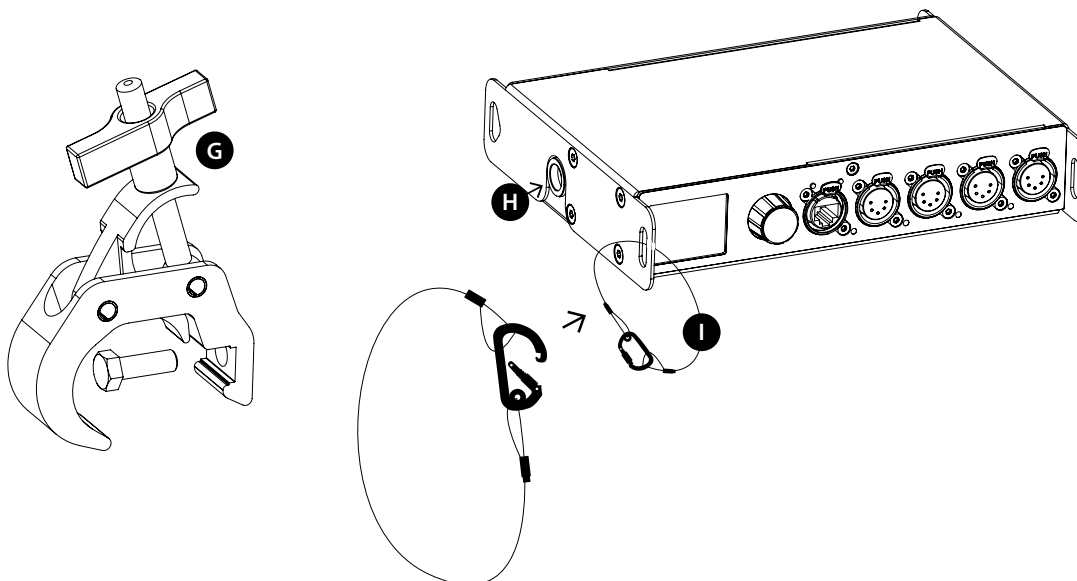

■ TRUSS MOUNT – LumiNode 2

To mount a LumiNode 2 in a truss, use the two plastic tie wraps that are included. Bring on each side a tie wrap through the holes of the device, around the truss bar and tighten it (J). Please also secure the device by attaching a safety line directly to the truss bars as well (K).

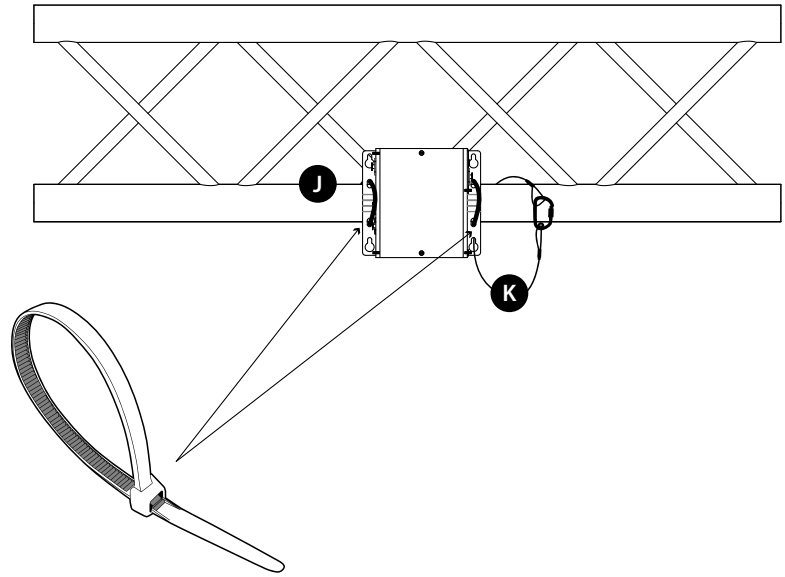

■ WALL MOUNT – LumiNode 2

The LumiNode 2 can be mounted to a concrete or wood wall by using applicable screws and anchors. Make sure that the screw head diameter is between 8 – 10mm and the screw length is at least 40mm in order to make a strong wall connection.

Drill 4 holes, at the correct distance in both directions as indicated in the picture below. Mount the device in such way that the Ethernet and DMX ports are facing sideways, and the chassis side is perpendicular to the ground.

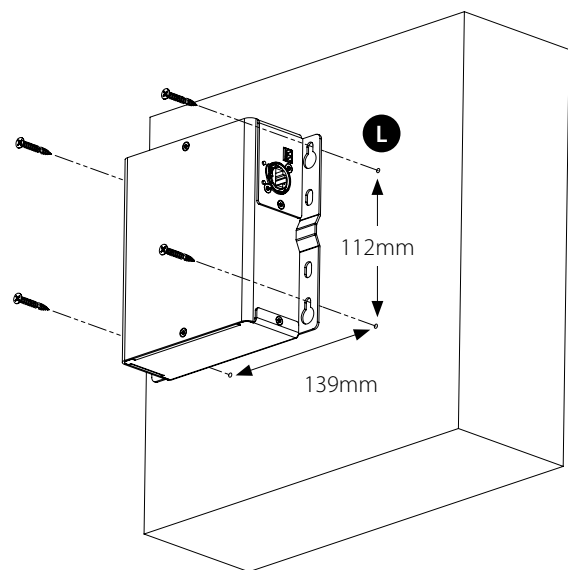
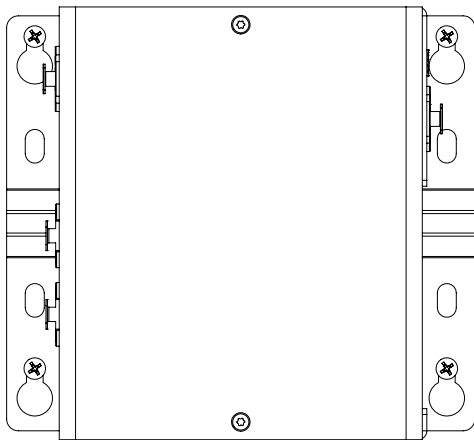
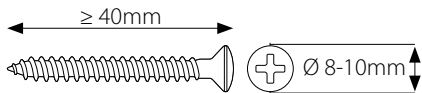

1.2 Power up the device

Depending on the model there are different ways to power your device:

- LumiNode1: Power-up the device with a USB cable (U) or with PoE (N). The device will automatically switch on. To shut it down after use, just un-plug the USB cable or the network cable again.
- LumiNode2: Power-up the device with a network cable with PoE (N). The device will automatically switch on. To shut it down after use, just un-plug the network cable again.
- LumiNode4 and 12: Power-up the device with a power cable fitted with a Neutrik PowerCON TRUE1 connector (M) (please contact your local dealer if you do not have a suitable power cable at hand). The device will automatically switch on. To shut it down after use, just un-plug the power cable again. LumiNode4 and 12 can also be powered with PoE (N).

The LumiNode 4 and 12 require standard AC power distribution from 100-240VAC, 50/60Hz. Current required depends on the model.

The mating Neutrik® powerCON® TRUE1 connector is supplied; however, you will need to purchase or construct a cable appropriate for your application.

When installing a new connector please refer to the following wire colour code reference:

| WIRE* | CONNECTION |
|--------------|------------|
| Green/Yellow | AC Ground |
| Blue | AC Neutral |
| Brown | AC Line |

* International (Harmonised) Standard

Alternatively, the LumiNode series are 802.3af compliant (PoE), so that each LumiNode will act as a PD (Powered Device) and can be powered by any compliant PSE (Power Sourcing Equipment) such as Ethernet switch, midspan and PoE injector. All models can only be powered with PoE via Eth2!

For LumiNode 4 and 12, if both AC power and PoE are used the AC power supply will be prioritized but the PoE will seamlessly take over if the AC power fails.

The LumiNode12 offers the option to daisy chain up to 30 devices via the PowerCON TRUE1 outlet on the rear of the unit.

LUMINODE 1

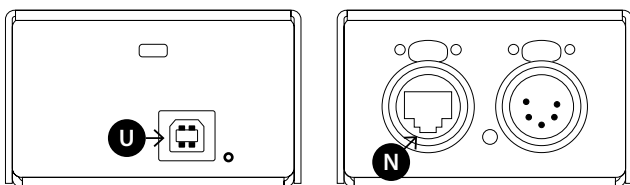

LUMINODE 2

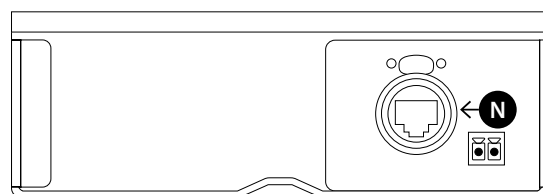

LUMINODE 4

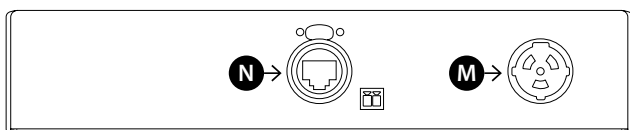

LUMINODE 12

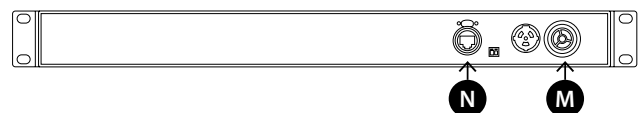

1.3 Connection

■ CONNECTION TO THE NETWORK

To get the LumiNode online in your system, connect either the Ethernet 1 or Ethernet 2 port to a computer, or to a port of an Ethernet switch. Only Ethernet 2 port on the rear of the unit can be used to power the unit through PoE. Check the port labelling for a better identification.

■ CONNECTION TO THE USB PORT

The LumiNode 1 can be powered through its USB port. Connect the LumiNode to the USB port of your computer.

The red LED next to the USB port of your device will turn on once the unit is powered. Once the unit has booted up the led will turn blue.

Additionally, the LumiNode will appear as a new network interface on your computer. No driver needed, the LumiNode supports Windows, Mac OSX and Linux OS. Once the network adaptor has been added please configure a static IP address in the range you are planning to use for your application in the settings of your operating system.

1.4 LED indicators

There are various LEDs on the LumiNode. Here is a list of the LEDs, the possible colors and the meaning of each color

| DMX PORT | STATUS | MEANING |
|-------------------------|--------------------------------|------------------------------|
| DMX Input | Green | Blinking : Active input |
| DMX only (output mode) | Cyan | Blinking: DMX activity |
| DMX + RDM (output mode) | Blue | Blinking: DMX activity |
| Stream loss | Red | Source stream lost |
| Stream recovered | Orange | Source stream recovered |
| DMX redundancy | Magenta Magenta flashing | Output idle Output active |

| NETWORK PORT | | |
|------------------|--------------------|--|
| Left LED (Link) | Green | Gigabit connection Blinking: Ethernet Traffic |
| | Orange | 100Mbit connection |
| Right LED (Mode) | Blue | Default color |
| | Green flashing | Device booting |
| | Orange blinking | Firmware upgrade in progress |
| | Green blinking | Identify in progress |

| USB PORT | | |
|------------------|--------------------|--|
| USB (node1 only) | Red | Powered from USB or PoE during bootup |
| | Blue | Unit booted and running |
| | Orange blinking | Firmware upgrade in progress |
| | Green blinking | Identify in progress |

1.5 Connection to the web interface

- The LumiNode IP address is displayed at the rear or on the bottom of the unit. On the LumiNode 4 and 12 this can also be found on the LCD display. Set your computer with a compliant IP address (do not use the same IP address!).
- Connect your computer to the LumiNode with a network cable.
- Launch your favourite web browser.
- Type the IP address of the LumiNode in the address field followed by enter.

1.6 Reset

When the device is powered up, by default it shows the status screen with the status of the first 4 ports. In order to reset the device please follow the following steps:

- Press the jog wheel once to enter the Main menu.
- Scroll down until you see Toolbox.
- Press the jog wheel once to enter the toolbox.
- Scroll down until you see Reset.
- Press the jog wheel once to enter the reset menu.
- A pop-up window opens giving you the option to Preserve IP settings and Preserve user profiles.
- Choose which option you want by using the jog wheel to scroll between the two options and press the jog wheel to confirm.
- At the bottom of the pop-up window you have the option to Reset or Cancel.
- If you choose Cancel you get a message that the reset has been cancelled.
- If you choose Reset, you get a new screen asking to confirm the reset command. Once 'Yes' is selected the LumiNode will reset.

How to reset LumiNode through Luminet Monitor:

- With a computer connected to the device, open Luminet Monitor.
- Under "Tools" in the menu bar you find "Reset LumiNode".
- Enter the mac address of the device you want to reset. This can be found on the label with the IP address.
- Choose if you want to keep the IP settings.
- Choose if you want to keep the profiles.
- Click reset.

2. CONFIGURATION

2.1 Web Interface Presentation

Launch your favorite web browser and type the IP address of your LumiNode. Press enter to validate.

■ NODE PAGE



(A) Identify: Clicking on the Luminox logo will identify your LumiNode in the network. The LCD display will turn GREEN and the Mode LED will flash GREEN for 5sec. In the web-UI you get the text “Identified” under the Logo and the LCD area will change colour.

(B) Image of your LumiNode: Depending on the model you are using; the image might differ from the one displayed above. This product image shows the configuration of each DMX port. The centre icon within each DMX port represents an input or an output. On the top of each port, you can see the mode of the process engine linked to that port.

(C) Navigation menu

(D) Input: According to the mode set on the process engine, the input block will display all relevant information, such as the type of incoming protocol, the universe number, the source IP address, or the DMX input port.

(E) Process engine: By default, the LumiNode comes with Forward mode activated on as many process engines as DMX port(s). The block displays the mode currently set on the process engine; you can change the name. On the left and on the right-hand side of the process engine, are respectively the patch and master / limiter icons. The colour of the icon will change if any parameters of these menus are modified. For more details about the process engines and how to configure them please see chapter 6 of this manual.

(F) Output: The output block will display all relevant information, such as the type of outgoing protocol, the universe number, the destination IP address, or the DMX output port.

(G) Increment / Decrement: Use these shortcuts to quickly increase or decrease the value of a universe. Select the Process engine first, after which the increment / decrement tool becomes available.

(H) Reset tool and padlock: Use this tool to reset one or several process engines. First select the process engine(s) by clicking on the top left corner of the input block followed by the trash can icon. The padlock allows you to lock the LumiNode configuration page to prevent unsolicited action on the web page only. This is an ideal tool for show time.

(I) Clear Warnings: Clear all stream loss indications.

(J) Active Profile: In this area the current active profile of the LumiNode is being displayed.

(K) Theme and language: Select here if you want to use the dark theme or light theme. Interface supported languages are English and Japanese for now.

(L) Help: In case you need help, here you find an onboard helpfile.

How to reset a process engine

To reset a process engine, follow the following steps:

- Hover your mouse over the top left corner of the process engine and select the tick box.
- Click on the trash can icon at the top right corner above the first process engine.

A blank process engine appears as follows:



How to configure a process engine

To configure a process engine, first click on the “SELECT MODE” label (the centre block of the process engine), the process engine panel appears. Click on the icon to select the mode you wish to use. Modes are described in chapter 5 of this manual.

- **Forward**, an input is sent to an output
- **LTP merge**, Latest Takes Precedence with up to four inputs
- **HTP merge**, Highest Take Precedence with up to four inputs
- **Backup**, Input 2 becomes active if input 1 is not available
- **X-Fade**, Cross-fade between input 1 and input 2
- **Switch**, with the use of a control source choose which of the up to four inputs is+ active
- **Custom**, any of the other modes, or combination of, on a channel level

At any time, you can click on the Patch button , or the Master / Limit button , to open the relevant configuration panel.

Next, click on the left-hand block, to select your input . According to the selected mode, the number of inputs may vary. A process engine supports up to four inputs.

If you want to reset all the process engines at once, navigate to the top left above the first process engine and select the tick box “Select all Process Engines”.

Input options are:

- **DMX**: Physical input on the XLRs.
- **ArtNet**: Select the ArtNet universe to use. You can enter a numeric value between 0 and 32767.
- **sACN**: Select the sACN universe to use. You can enter a numeric value between 1 and 63999.
- **RTTrPL**, BlackTrax: Select the RTTrPL universe to use. You can enter a numeric value between 0 and 63999.
- **Internal**, the result of another process engine.
- **Play**, one of the recorded shows.

You can give your input a name for easy identification. Next, select your output , by clicking on the output block, located on the right-hand side.

Here, you can choose between DMX, ArtNet, sACN or a combination of the three to send data coming from the process engine. The three types of output can be used at the same time, providing you with great flexibility.

Once selected, click on the Save button to store the parameters of your process engine. Your engine is ready to go!

How to quickly copy a process Engine

Once you have created your first process engine, select it by clicking on the tick box in the top left corner. A handle appears at the bottom centre of the process engine.

Click and drag the handle down, to select other process engines. The LumiCore will automatically increase the universe number for each following process engine. This allows you to create a complete configuration in a snap!

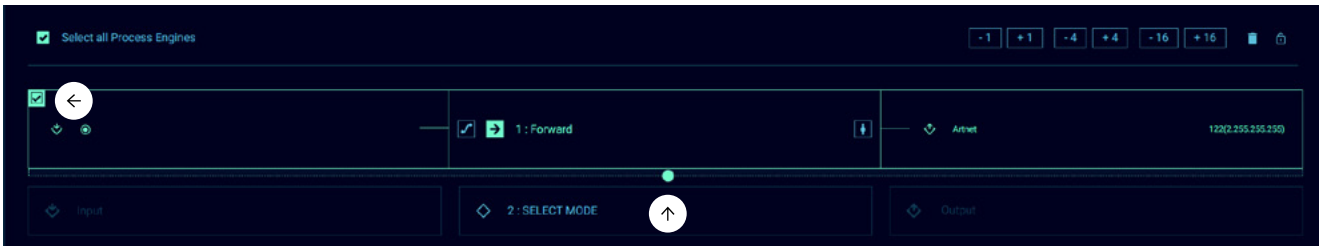

THE DMX / RDM PAGE

The DMX / RDM page is divided in two sub menus:

Port Settings

The port settings offers you to:

- Add a legend to a port to easily identify what is connected to it. This will also update the tooltip on the configuration page of the process engine.
- Enable Sync mode: when enabled the DMX output framerate is matched to the input framerate. If the source used for this port has the ability to send an ArtNet or sACN sync packet this will be used.
- Redundant Slave: when enabled the DMX port listens to incoming DMX from another port or another node and will start outputting if NO input is registered. When DMX redundant slave is enabled RDM is automatically disabled.
- Enable RDM, enabling RDM allows RDM traffic to be transported from/to an outlet over the network and back.
 - Adaptive discovery. When RDM is enabled it is possible to enable Adaptive Discovery. This will continuously check for new and disappeared RDM devices on the output.
 - Interweaving. Interweaving is enabled by default. Interweaving is only available when the FPS is set lower or equal to 34fps. Interweaving makes that RDM messages are interweaved with DMX. If your fixture does not support interweaving or the RDM packets you are sending are too large you would disable RDM interweaving. For example, with a RDM based follow-spot system interweaving needs to be disabled.
 - ArtRDM universe. The ArtRDM universe is the universe which is used for ArtTOD and ArtRDM packets. By default, this will be matched to the ArtNet universe of the first ArtNet input of your process engine.

Scroll down and click "Save" to save your settings.

At the bottom of the process engine section you can find a button to force an RDM discovery in case this is required.

DMX Settings

On the DMX / RDM page at the bottom of the page you find the DMX settings.

- DMX Framerate in Frames Per Second
- Breaktime in microseconds
- DMX output time continuous by default is enabled and the LumiNode will keep outputting the last received stream packages on the DMX. When you disable the continuous output time you can choose a time the LumiNode will keep outputting the data with a minimum time of 1 second.
- RDM Controller IP is the only device in the network that can make changes via RDM. When 0.0.0.0 every device in the network can make changes but if you want to have a dedicated device to manage the RDM you can define the IP here.

Press "Save" to apply your settings

DMX REDUNDANCY

The LumiNode range supports DMX redundancy from firmware 2.1.0 onwards. What does DMX redundancy mean and how does it work?

DMX redundancy means that you can run a DMX cable from one LumiNode to your lights and then from the output of the last light back to the same LumiNode or to a different LumiNode.

(If the redundant port is on the same LumiNode, only one process engine is required to configure both ports).

The redundant port will not output DMX until it is no longer receiving DMX.



Once a link in the DMX chain gets broken or disconnected the slave port will start outputting DMX and the lights will continue to operate as expected.

As soon as the broken link is restored the redundant port will go back to an idle state.



NOTE: For this system to work between different LumiNodes, it is important that the configuration of both process engines and the settings for sync and dmx framerate are identical!

When the redundant port is in idle state, the port LED is solid magenta and the LCD display on the LumiNode 4 and LumiNode 12 will show the outline of the output symbol in magenta.

As soon as the port becomes active the port LED will turn to flashing magenta and the LCD display will show a magenta filled output symbol.

Redundant port **NOT** active:

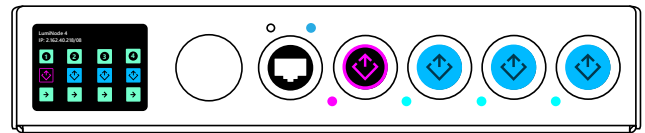

Redundant port **ACTIVE**:

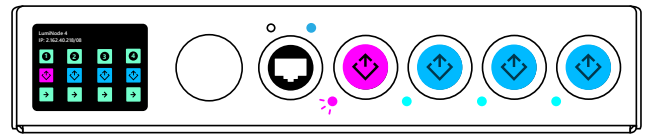

■ PLAY PAGE

The play page is divided in two sub menus:

Show:

Here you can select which show you want to record, which cue number and the fade time in seconds.

Other options here are:

- **Import** a show that you have available offline.
- **Export** the show you have selected to your computer.
- **Delete** the selected show.
- **Cue** is the cue number that will be stored next.
- **Fade(s)** is the fade time in seconds assigned to the cue when recorded in the web interface.
- **Rec** records a new cue. Each cue is a snapshot of the output of all process engines.

Record Trigger:

When you scroll down on the play page you will find the Record Trigger settings.

Here you can set the record channel. This is the channel you will be sending from your control device, the control source protocol and universe. This can also be assigned to a specific source IP address if required.

The following options with corresponding values are available for the record trigger:

- 101 – record next cue in show 1
- 102 – record next cue in show 2
- 103 – record next cue in show 3
-
-
- 139 – record next cue in show 39
- 140 – record next cue in show 40

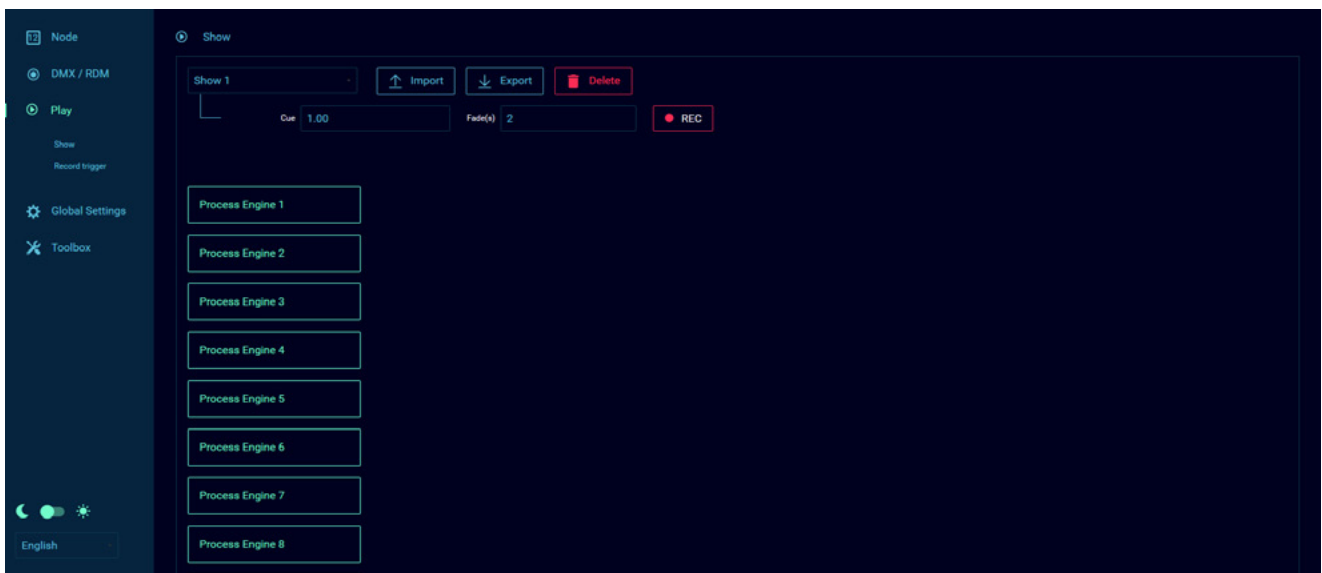

TOOLBOX PAGE

The toolbox page is divided in three sub menus:

Profile manager

Here, you can recall, save, import, export or delete a profile; Select the profile with the drop-down menu located on left hand-side. The LumiNode comes with default profiles that can be used or modified, for a fast setup time. Up to 40 profiles can be stored in a unit.

Once a profile is selected, you can preview the configuration below. IP settings included in the profile are displayed at the bottom of the profile.



When a profile has been selected the user can scroll down to the bottom of the profile preview to see the IP settings in this profile. By default, the LumiNode will NOT load the IP settings

that are stored in the profile. If you want to load the IP settings saved in the profile, slide the "Preserve IP settings" to OFF.

Firmware

Here, you can see two types of firmware:

- **Active firmware is the one currently running on the unit.**
- **Alternate firmware is the previously installed firmware.**

If you'd like to downgrade the unit to the previously installed firmware, click on the "Activate" button. The unit will reboot with this firmware.

There is only ONE firmware version for the entire range. This can be installed on all different models in the range.

You can upgrade the LumiNode with our latest firmware. To upgrade the unit, please apply the following procedure:

- Download the latest firmware from the support section of our web site.
- Extract the downloaded archive and have a look at the release notes included.
- Click on the firmware upgrade button.
- Select the file you have extracted.
- The LumiNode will start the firmware upgrade. The unit will reboot after the upgrade is completed.

Reset

In this panel, you can reset the LumiNode, with two separate options:

- **Preserve IP address**, all settings get restored to factory default apart from the IP address set to reach the device. Custom profiles are all deleted and modified default profiles are restored to default.
- **Preserve profiles**, during the reset the custom stored profiles and modified default profiles are being kept.

Click on the "Reset" button to perform the selected reset.

Performing a reset with these two options disabled will bring the LumiNode to its factory settings.

3. GLOBAL SETTINGS

The global settings page is divided in five sub menus:

3.1 Control source

Here, you can set the type of protocol, the universe number, and the controller IP address for each control source. If the IP address 0.0.0.0 is used all devices in the network generating the assigned control protocol and universe can be the control source. The LumiNode will use an LTP merging policy between the first four sources that become available. When using sACN the priority is also important to consider. Each control source can be a different protocol, universe, and controller IP.

Press "Save" to apply your settings.

3.2 IP settings

In this menu, you can set the IP address, subnet mask and default gateway for your LumiNode.

The Broadcast address displayed below is the default destination IP address the LumiNode will be using when sending ArtNet to the network.

Press "Save" to apply your settings.

3.3 Device Settings

In this menu, you can set:

- **Short name.** Enter a name of maximum 17 characters to indicate the node on ArtNet. The following characters cannot be used: ^[~]*\$.
- **Long name.** Enter a name of maximum 63 characters to indicate the node on ArtNet. The following characters cannot be used: ^[~]*\$.
- **ID number** of the LumiNode. The ID number is used for indication only.

Press "Save" to apply your settings.

The device settings window also shows the Mac address and serial number of your device.

3.4 Contact Closure (LumiNode 2, 4 and 12 ONLY)

In this menu you can setup the details for the contact closure.

- **Protocol** can be ArtNet or sACN.
- **Universe** is the universe created by the contact closure.
- **Destination IP / Priority** allows you to broadcast or unicast the contact closure's universe when using ArtNet. If no IP is entered the broadcast address will be auto filled. When sACN is chosen as protocol this becomes the priority.
- **Channel** is the control channel created by the contact closure.
- **Open** is the value (0-255) of the control channel when the contact is open.
- **Closed** is the value (0-255) of the control channel when the contact is closed.

Press "Save" to apply your settings.

The following values are linked to the options Switch, Play and Backup: (these can be found under the question mark symbol on the Global Settings page/Contact Closure).

- General
 - Do Nothing: 0 – 7
- Switch
 - 8 – 15: Input 1
 - 16 – 23: Input 2
 - 24 – 31: Input 3
 - 32 – 39: Input 4
- Play
 - 8 – 15: Go
 - 16 – 23: Forward
 - 24 – 31: Back
 - 32 – 39: Reset
 - 101 – 140: Record
- Backup
 - 8 – 15: Recovery

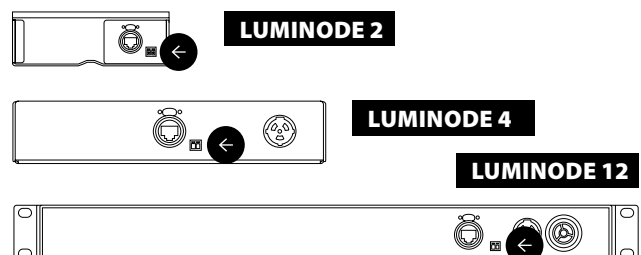

Miscellaneous

- **LCD auto-off (sec)** allows you to set the LumiNode to automatically switch off the LCD after the set time. By default, this is set to 600 sec. If the value is set to zero, the display will always stay ON.
- **LCD pin** allows you to set a PIN to lock changing settings via the LCD screen. Click on the slider to enable the LCD pin.
- **Web auth**, for security reasons, a password can be enabled on the LumiNode web interface. Click on the slider to enable web authentication, and type in your password.
- **Led slider** allows you to change the brightness of the LEDs on the LumiNode.

Press "Save" to apply your settings.

4. LCD DISPLAY (LumiNode 4 and 12 ONLY)

From firmware version 2.0 onwards the LCD display has been activated and the following information can be found on the display. In normal operation the LumiNode will step through the port overview pages depending on the total amount of ports on the model. The display will change every 5 seconds.

The image (1) to the right shows the layout of the display:

- **(A)** Model number
- **(B)** IP address / Netmask
(/8 = 255.0.0.0, /16=255.255.0.0, /24=255.255.255.0)
- **(C)** Port number
- **(D)** Shows if the port is Input ↕ or Output ↗
- **(E)** Shows the mode of the port

For a more detailed view per port you can use the jog wheel and scroll to the right (image 2). Example of detailed port info:

- **(A)** Port number you are viewing
- **(B)** When RDM is showing RDM is active on this port
- **(C)** Shows if the port is an Input ↕ or Output ↗
- **(D)** Shows the input of the process engine, what protocol and which universe
- **(E)** Displays which process engine is linked, what mode the process engine is in, if there is a patch or if the master/limit has been set
- **(F)** Shows the output of the process engine, universe number and protocol

If a stream fails on a port the LCD display will show this by changing the Output (D) Red (image 3).

If the lost stream is recovered the LCD display will show this by changing the Output (D) Orange. This way the user can see the stream has been lost (image 4).

In order to clear the warnings, scroll to the following display and press the jog wheel. This screen can be found when scrolling left once when ports 1-4 are shown or to scroll all the way to past the last detailed port info (image 5).

If the port is in DMX redundant mode and idle the output icon has a magenta outline (image 6).

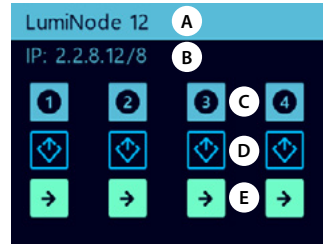

Image 1

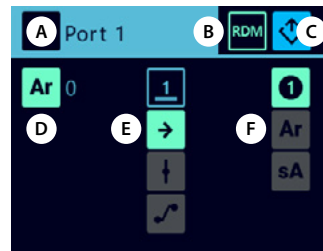

Image 2

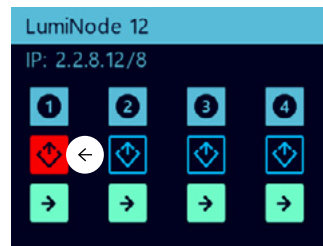

Image 3

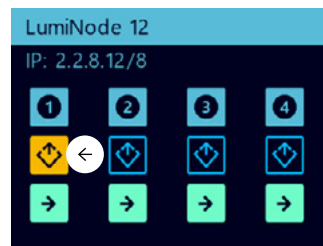

Image 4

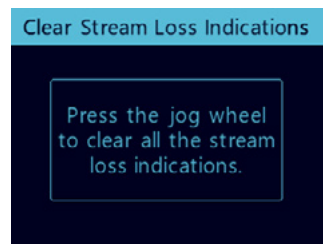

Image 5

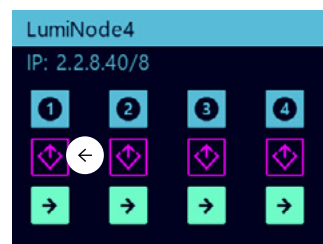

Image 6

If the port is in DMX redundant mode and active the output icon is solid magenta (image 7).

The front-end display offers access to most of the settings in the unit.

MENU TREE VIEW:

Home

- Ports
 - Status overview of the ports
- Process Engines
 - Status overview of the process engines
- Setup Port
 - DMX / RDM Setup
 - Sync
 - Redundant Slave (Not available if RDM is enabled)
 - RDM Enabled
 - Adoptive discovery ON/OFF
 - Interweaving ON/OFF
 - Fast Engine Setup
- Setup Process Engine
 - Configuration of process engines
- Setup Network
 - IP
 - Subnet
 - Gateway
 - Mac address
- Profile Manager
 - Save
 - Recall
- Device Info
- Toolbox
 - Display Off
 - Reboot
 - Reset
 - RDM Discovery
- Display Setting
 - Dark / Light
 - Display Off
 - Language
 - Enable / disable screensaver
 - Enable / disable auto rotate status page

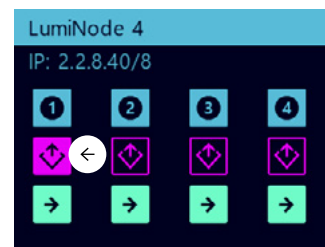

Image 7

5. WEB API

The LumiNode range supports the use of Web API. For a detailed list of available actions via Web API please type the following in your favourite web browser:

http://www.IP_OF_YOUR_DEVICE/api/doc

6. LUMINODE IN DETAIL

The LumiNode series is a new range of network converter, inheriting more than a decade of experience from the Luminex Ethernet-DMX converter design and manufacturing.

In the past, most of the people were designing their system according to the number of universes and DMX ports they would need on their lighting control system.

But today, with the ever-increasing number of lighting-controlled devices fitted with an Ethernet port, there is a need for more processing power and data handling flexibility. This is where the LumiNode series steps in.

Instead of assigning universes to a port, the user can now select any incoming data, handle it the way they need, and send it back to the network, or to a DMX port. All the data handling will be powered by process engines.

6.1 What is a Process engine?

A Process engine can be seen as an entity within the LumiNode firmware, accepting up to four sources, and who is able to send it up to three different destinations. Additionally, remote interaction and control can be applied to the process engine, via specific control channels.

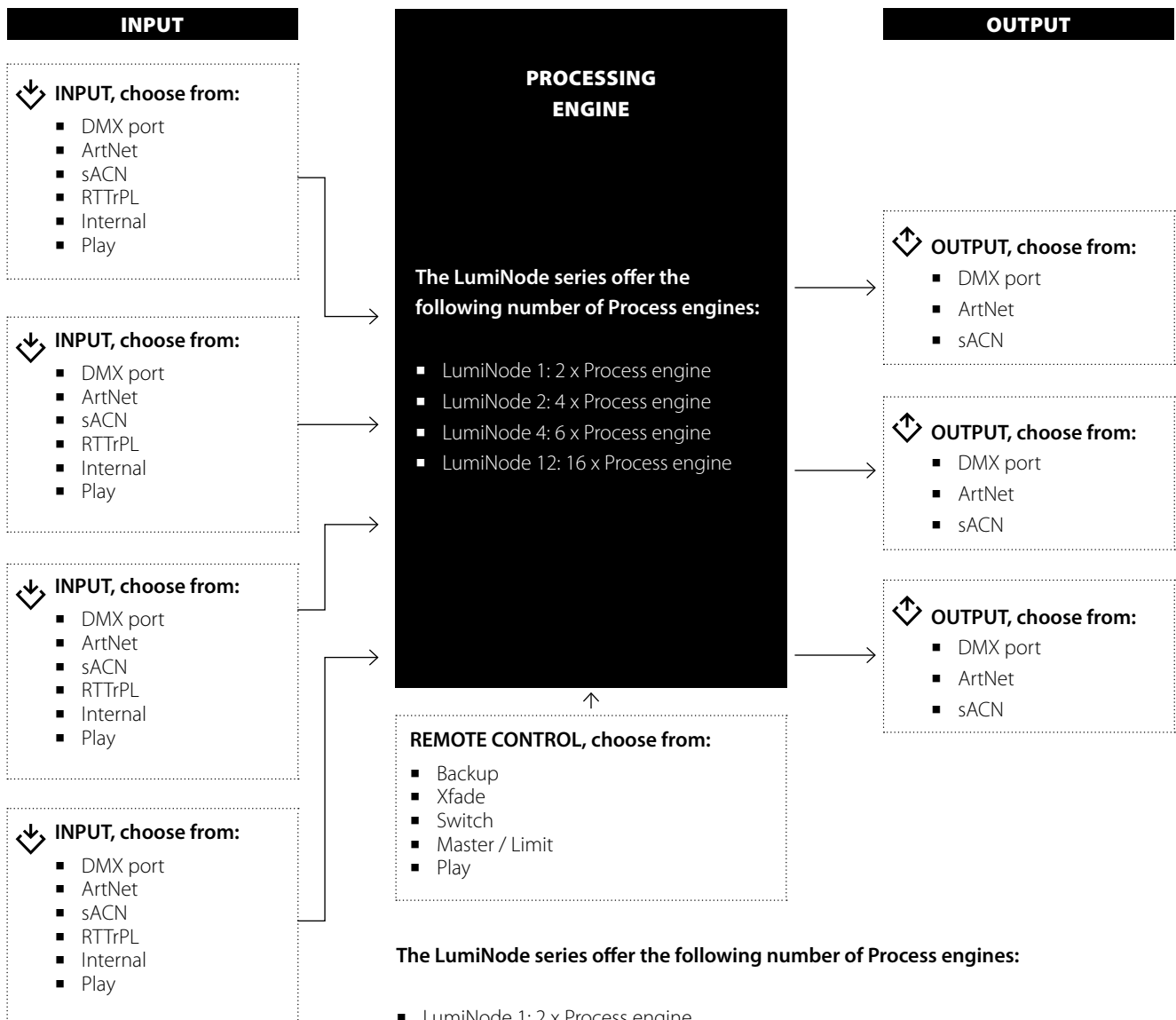

The LumiNode series offer the following number of Process engines:

- LumiNode 1: 2 x Process engine
- LumiNode 2: 4 x Process engine
- LumiNode 4: 6 x Process engine
- LumiNode 12: 16 x Process engine

■ INPUT

A process engine supports the following inputs:

DMX:

A DMX source, such as a lighting control desk, can be connected to any of the DMX port(s) of the LumiNode. You will need to use a male to male adapter to connect the console to the DMX port of the LumiNode. In the input configuration you click on the port you wish to use as an input port, to enable the DMX input.

A greyed-out port with a diagonal bar in it means this port is already used.

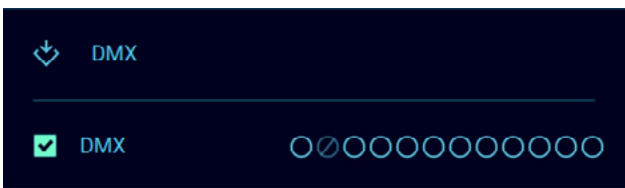

ArtNet:

Any ArtNet controller can be used as an input for the process engine. The LumiNode supports all ArtNet revisions, including ArtNet IV. Tick the box to select ArtNet as an input protocol.

Here you can add the universe number you wish to use, and you can specify the IP address of the source. If you leave the source IP field 0.0.0.0 any source in the network outputting this universe will be used. The LumiNode process engine will bound this input to the first source using this universe number.

For a better identification of the source you can add a text to your ArtNet input.

Advanced settings:

Next to the Source IP field you find a cog wheel for advanced settings:

- **Accept Own Data.** In some cases, it is required to ignore the ArtNet data generated by the LumiNode itself. When disabled the LumiNode will now only listen to other sources in the network.
- By default, the "Accept Own Data" is enabled.

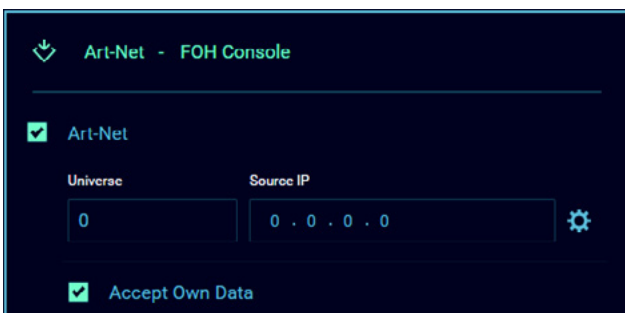

sACN:

Any sACN controller can be used as an input for the process engine. Tick the box to select sACN as an input protocol.

Here you can add the universe number you wish to use, and you can specify the IP address of the source.

If you leave the source IP field 0.0.0.0 any source in the network outputting this universe will be used. The LumiNode process engine will bound this input to the first source using this universe number.

For a better identification of the source you can add a text to your sACN input.

Advanced sACN settings:

Next to the Source IP field you find a cog wheel for advanced settings:

- **Per-channel Priority Mode.** To better handle multiple source control scenarios, the OxDD sACN start code has been introduced to allow setting a source priority for each channel of a universe. The following rules apply:
 - If all sources have the same priority HTP will be applied.
 - If for a source the OxDD packet is not available, the standard universe priority is being used.
 - The number of sources is unlimited.
- **Accept Own Data.** In some cases, it is required to ignore the sACN data generated by the LumiNode itself. When disabled the LumiNode will now only listen to other sources in the network. By default, the "Accept Own Data" is enabled.

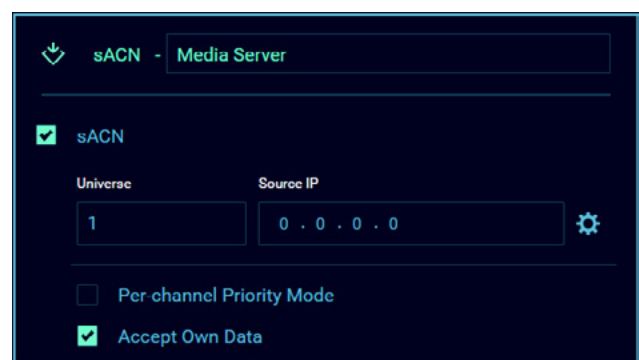

RTTrPL:

The LumiNode process engine supports Real Time Tracking Protocol for Light, by Cast Software. As an example, the LumiNode can be used to transition between a lighting console and a BlackTraX tracking system, seamlessly. Tick the box to select RTTrPL as an input protocol. Here you can add the universe number you wish to use, and you can specify the IP address of the source.

If you leave the source IP field 0.0.0.0 any source in the network outputting this universe will be used. The LumiNode process engine will bound this input to the first source using this universe number.

For a better identification of the source you can add a text to your RTTrPL input.



For a better identification of the source you can add a text to your Internal source.

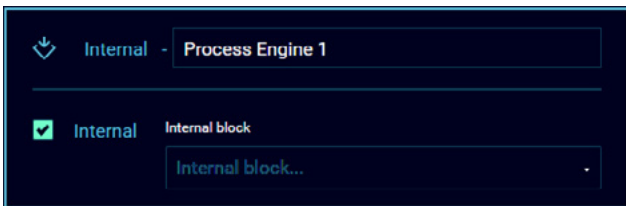

Play:

This input option allows you to use the recorded cues from internal shows as an input to the process engine. First select which show you want to use, then select the process engine that you want to use. All the process engines of the LumiNode are always available to choose from. For a better identification of the source you can add a text to your Play source.

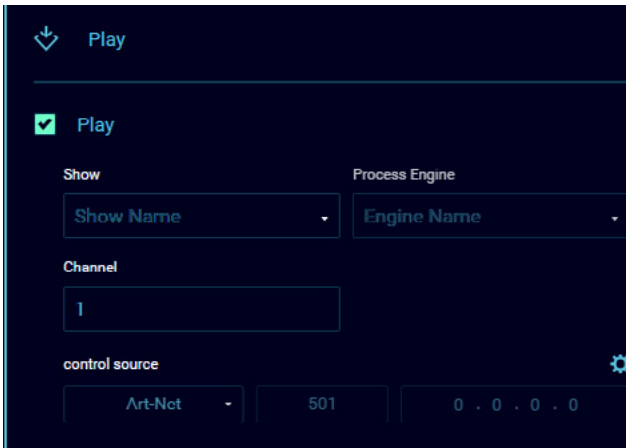

Select the control channel you want to use to control the cue list. Use the cog wheel to set the source protocol and universe and if required a specific controller IP.

Control channel options:

- 8 – 15 Go, play the next cue in the cue list.
- 16 – 23 Forward, preset the next cue. This allows you to trigger forward for example twice to skip a cue.
- 24 – 31 Back, preset the current cue again. To go to the previous cue, you need to trigger this option twice.
- 32 – 39 Reset, reset the cue list to the first cue in the list.

■ OUTPUT

A process engine offers the following outputs:

DMX:

One or several DMX ports can be selected to output the data transferred by the process engine. A greyed-out port with a bar in the middle, means this port is already used.

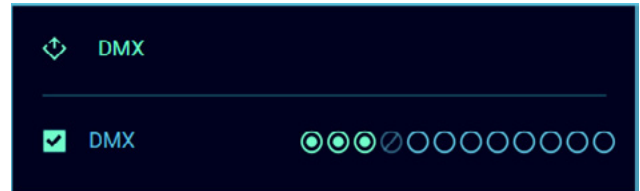

ArtNet:

All data handled by the process engine can be sent back to the network as a new or the same ArtNet universe.

Here you can set the universe number you wish to use. You can specify the IP address of the destination, by ticking the Unicast box. By default, the LumiNode will transmit this ArtNet universe to the broadcast address of the IP range the unit is part of.

For a better identification you can add a text to your ArtNet destination.

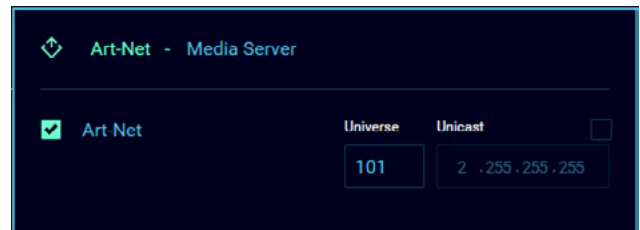

sACN:

All data handled by the process engine can be sent back to the network as a new or the same sACN universe.

Here you can set the universe number you wish to use, and you can specify the priority for this sACN universe.

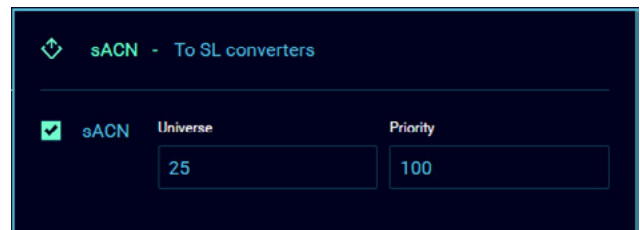

■ MODE DEFINITION

The LumiNode series offer 7 different modes for each process engine:

FORWARD:

In forward mode one input source is send to up to 3 outputs. You can output to a physical port on the converter, forward to another

ArtNet or sACN universe, or any combination of the three.

LTP MERGE:

Latest Takes Precedence merging policy is commonly used to merge fixture channels. Up to 4 inputs (ArtNet, sACN, DMX, RTTrPL, Internal, Play or combination of) can be merged.

Patch and Master/Limit options are available for this mode.

HTP MERGE:

Highest Takes Precedence merging policy is commonly used to merge dimmer channels. Up to 4 inputs (ArtNet, sACN, DMX, RTTrPL, Internal, Play or combination of) can be merged.

Patch and Master/Limit options are available for this mode.

BACKUP:

In Backup mode, two inputs will be used which can be DMX, ArtNet, sACN, RTTrPL, Internal or Play where the first input has precedence over the second input. The output can be DMX, ArtNet, sACN or any combination of the three.

When input 1 fails the node will switch to input 2, automatically. Auto-recover is enabled by default.

Auto Recovery

- When auto recovery is Enabled the LumiNode will switch back to input one as soon as this is back available in the network. In this case the warning for the missing backup control source can be ignored.
- When auto recovery is Disabled you can configure which protocol is used to trigger the recovery, which universe and which channel. This can be narrowed down to a specific IP address which will be the only device able to control the backup recovery.



The red warning triangle is a warning that the process engine cannot be configured without a backup control source. This is to indicate that the control source has not been configured yet for remote recovery. As soon as the control source has been configured this triangle will disappear.

When the backup control option is used, the LumiNode will not restore to input one when this becomes available in the network. To recover, a value between 8-15 (0-255) needs to be send on the control channel to trigger the recovery.

Patch and Master / Limit options are available for this mode.

X-FADE

This mode offers to you to cross fade between two sources. Ideal in a situation where you need to cross fade between a lighting desk and a media server, the control channel allows you to keep full control on the speed and smoothness of the transition. From the X-Fade panel, you can define the control channel, the protocol and universe number, as the IP address of the control source. Click on the gearwheel icon to change these parameters.

When the control channel is at zero, source one is in full control, when the control channel is at full, source two is in full control.

Patch and Master/Limit options are available for this mode.



The red warning triangle is a warning that the process engine cannot be configured without a X-Fade control source. This is to indicate that the control source has not been configured yet for the X-Fade. As soon as the control source has been configured this triangle will disappear.

Patch and Master / Limit options are available for this mode.

SWITCH

The switch functionality provides you with an easy to use tool to remotely select within up to four inputs, which input can control your rig. By sending different values for the switch channel, you'll be able to select the relevant input. The switching between inputs does not include any crossfade.

From the switch panel, you can define the switching channel, the protocol and universe number, as the IP address of the control source. Click on the gearwheel icon to change these parameters.

 *The red warning triangle is a warning that the process engine cannot be configured without a Switch control source. This is to indicate that the control source has not been configured yet for the Switch. As soon as the control source has been configured this triangle will disappear.*

Patch and Master / Limit options are available for this mode.

Control channel mapping:

000 - 007 Do Nothing / Idle (current active source stays active)
 008 - 015 Input 1
 016 - 023 Input 2
 024 - 031 Input 3
 032 - 039 Input 4
 040 - 247 Future use
 248 - 255 Do Nothing / Idle (current active source stays active)

CUSTOM

This mode is ideal for a complex setup, or when per channel control is needed. Custom offers you to choose what policy to apply for each channel, and to create a complete custom soft patch.

Depending on the mode chosen, up to four DMX, ArtNet, sACN, RTTrPL, Internal or Play inputs can be merged in this policy.

The custom mode offers you to combine any mode or combination of modes including: Input 1 only, Input 2 only, Input 3 only, Input 4 only, LTP, HTP, X-Fade, Backup, and switch.

To get access to the custom patch panel, click on the patch icon.

From this panel, you can define the complete patch per input, with any merging policy, or control source (fig. A).

Use the "From To" tool to quickly apply a merging policy or mode to a range of channels.

Once the merging policies have been applied to the DMX channels, you will be able to assign a remote-control channel.

Use the "From To" tool to quickly apply a control channel to a range of DMX channels. Press the "Apply" button to save your settings.

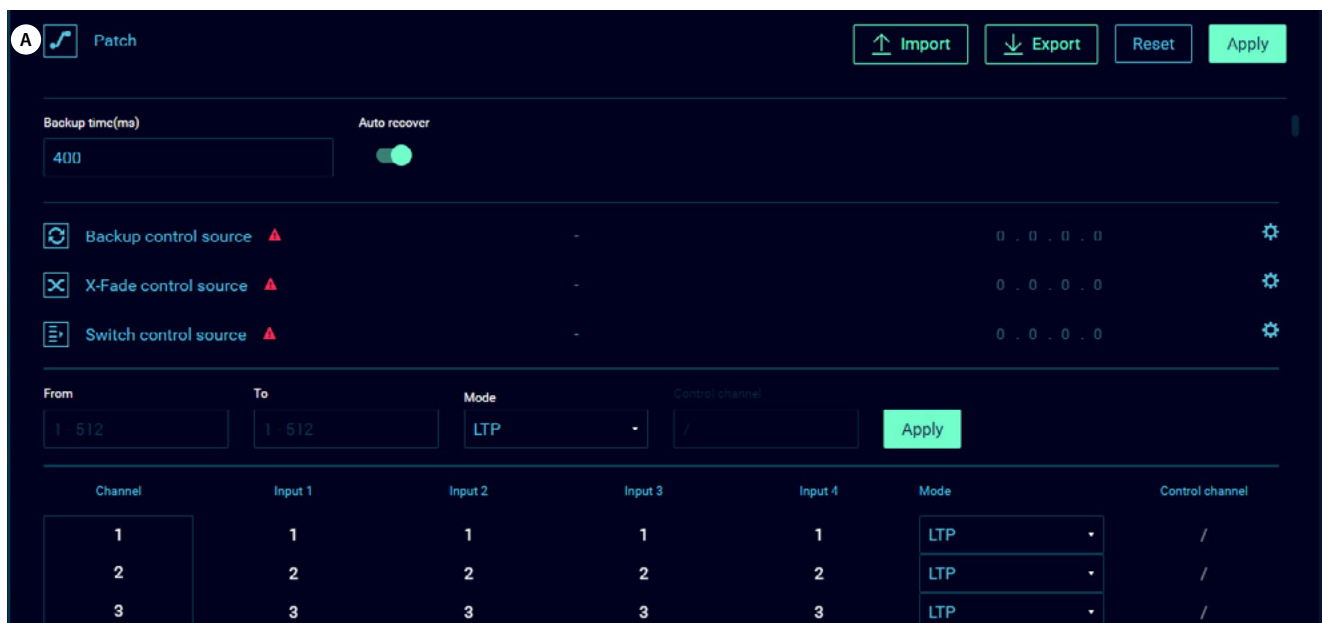

| Channel | Input 1 | Input 2 | Input 3 | Input 4 | Mode | Control channel |
|---------|---------|---------|---------|---------|------|-----------------|
| 1 | 1 | 1 | 1 | 1 | LTP | / |
| 2 | 2 | 2 | 2 | 2 | LTP | / |
| 3 | 3 | 3 | 3 | 3 | LTP | / |

PATCH OPTION

Depending on the selected mode you applied to your process engine, you will be able to modify the patch for your sources. Once in the process engine panel, click on the patch icon to open the patch panel.

From there, you can apply the patch you wish per channel. Press "Apply" to save your settings.

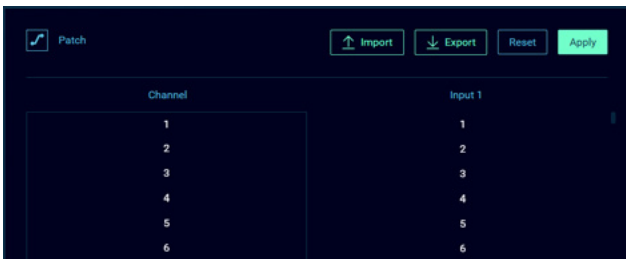

PATCH IMPORT / EXPORT

From firmware 2.2.0 we offer the option to import or export your patch. You can import a CSV or TSV file with your custom patch. The process engine will automatically configure the mode required based on your patch info.

To export a patch, open the patch option in the process engine configuration window and select "Export".

Choose a location to save the patch and choose "Save". This can be an easy way to start a custom patch to have the correct format for the patch file that you want to import at a later stage with your custom data. Once you have the exported file, you can change it and then import it again.

To import a patch, open the patch option in the process engine configuration window and select "Import". Browse to the file you wish to use on your computer and choose "Open".

The web-Ui will refresh and show the Node configuration page. Now configure your input(s) and output(s) as normal.

MASTER / LIMIT OPTION

Depending on the selected mode you applied to your process engine, you will be able to assign a master or limit channel to your output (fig. B).

Once in the process engine panel, click on the Master / Limit icon to open the configuration panel.

First select the mode you wish to use, by clicking on the Master/ Limit switch, on the top left corner of the panel.

You can define the control channel, the protocol and universe number, as the IP address of the control source. Click on the cog wheel icon to change these parameters.

From there, you can apply any Master / Limit control channel to your output channels. This can be the same for all channels or different per channel or group of channels.

Press "Apply" to save your settings.

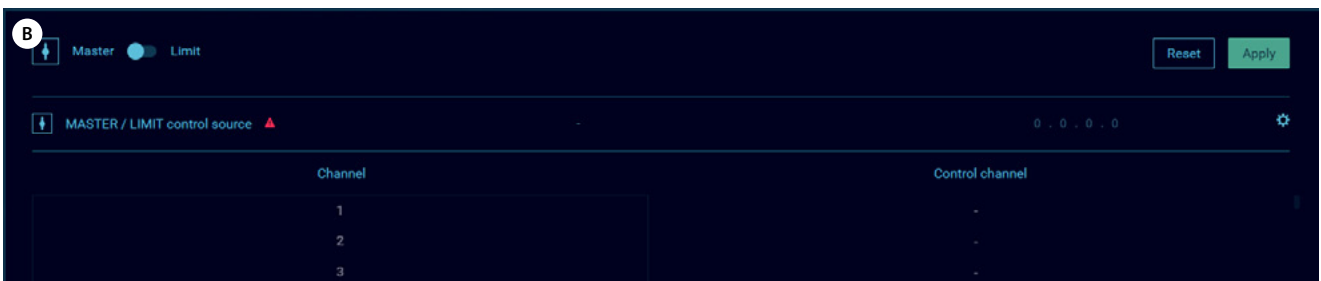

Master / Limit explained:**MASTER:**

When choosing the Master option, we configure a control channel to act like a grand master. You can reduce the output level whilst the relationship between channels is being respected. The output is scaled to each individual channel. (Master value * Channel value / 255)

For example:

Channel 1 = 204
Channel 2 = 229
Channel 3 = 128

If we now reduce the master channel to 204 the channels will output as follows:

Channel 1 = 163
Channel 2 = 183
Channel 3 = 102

LIMIT:

When choosing the Limit option, we configure a control channel to set a limit to the output. In this case the relationship between channels is not being respected.

For example:

Channel 1 = 191
Channel 2 = 153
Channel 3 = 128

If we now set the limit channel to be 178 the result will be as follows:

Channel 1 = 178
Channel 2 = 153
Channel 3 = 128

As the result shows, channel 1 has been reduced but channels 2 and 3 haven't been affected.

7. CREDITS

The following credits are available for this manual:

- Art-Net™ Designed by and Copyright Artistic Licence Holdings Ltd



- ANSI E1.20 – 2010 Entertainment Technology RDM, Remote Device Management over DMX512 Networks
- ANSI E1.31 – 2018 Entertainment Technology - Lightweight streaming protocol for transport of DMX512 using ACN.

Luminex
NETWORK INTELLIGENCE

YOUR NETWORK SOLUTION FOR
AUDIO, VIDEO AND LIGHTING

EFFECTIVE, RELIABLE, ACCESSIBLE



Luminex

Slamstraat 13 | 3600 Genk | Belgium | T +32 11 812 189 | info@luminex.be | www.luminex.world