

Chroma-Q® Inspire™ External Control Box UL924

User Manual



Chroma-Q®
BRILLIANT SOLUTIONS

Part Number: CHINHLCTRLBOX924
(Model: 632-5010)

Software Version (Adr.) 1.4
Manual: 632-0714, V2.0 Feb 2022

Warranty Statement



Chroma-Q® warrants to the original purchaser, with proof of purchase, that its delivered products shall be free from defects in material and workmanship under normal use for a period of 36 months from date of shipment.

Chroma-Q® will repair, or at its option, provide an equivalent item or replace, the defective product during the stated warranty period. This warranty applies only to the repair or replacement of the product and only when the product is properly handled, installed and maintained according to Chroma-Q® instructions. This warranty excludes defects resulting from improper handling, storage, installation, acts of God, fire, vandalism or civil disturbances. Purchaser must notify Chroma-Q® in writing within 14 days of noticing the defect. This warranty excludes field labour or service charges related to the repair or replacement of the product.

The warranty contained herein shall not extend to any finished goods or spare parts from which any serial number has been removed or which have been damaged or rendered defective (a) as a result of normal wear and tear, wilful or accidental damage, negligence, misuse or abuse; (b) due to water or moisture, lightning, windstorm, abnormal voltage, harmonic distortion, dust, dirt, corrosion or other external causes; (c) by operation outside the specifications contained in the user documentation; (d) by the use of spare parts not manufactured or sold by Chroma-Q® or by the connection or integration of other equipment or software not approved by Chroma-Q® unless the Customer provides acceptable proof to Chroma-Q® that the defect or damage was not caused by the above; (e) by modification, repair or service by anyone other than Chroma-Q®, who has not applied for and been approved by Chroma-Q® to do such modification, repair or service unless the Customer provides acceptable proof to Chroma-Q® that the defect or damage was not caused by the above; (f) due to procedures, deviating from procedures specified by Chroma-Q® or (g) due to failure to store, install, test, commission, maintain, operate or use finished goods and spare parts in a safe and reasonable manner and in accordance with Chroma-Q®'s instructions (h) by repair or replacement of engines without factory training.

The warranty contained herein shall not apply to finished goods or spare parts which are sold “as is”, as “second-hand”, as “used”, as “demo” or under similar qualifications or to Consumables (“Consumables” is defined as any part(s) of goods or part(s) for use with goods, which part(s) of goods or part(s) for use with goods are consumed during the operation of the goods and which part(s) of goods or part(s) for use with goods require replacement from time to time by a user such as, but not limited to, light bulbs).

The warranty contained herein shall not apply, unless the total purchase price for the defective finished goods or spare parts has been paid by the due date for payment.

The warranty contained herein applies only to the original purchaser and are not assignable or transferable to any subsequent purchaser or end-user.

This warranty is subject to the shipment of the goods, within the warranty period, to the Chroma-Q® warranty returns department, by the purchaser, at the purchasers’ expense. If no fault is found, Chroma-Q® will charge the purchaser for the subsequent return of the goods.

Chroma-Q® reserves the right to change the warranty period without prior notice and without incurring obligation and expressly disclaims all warranties not stated in this limited warranty.

Disclaimer

The information contained herein is offered in good faith and is believed to be accurate. However, because conditions and methods of use of our products are beyond our control, this information should not be used in substitution for customer's tests to ensure that Chroma-Q® products are safe, effective, and fully satisfactory for the intended end use. Suggestions of use shall not be taken as inducements to infringe any patent. Chroma-Q® sole warranty is that the product will meet the sales specifications in effect at the time of shipment. Your exclusive remedy for breach of such warranty is limited to refund of purchase price or replacement of any product shown to be other than as warranted.

Chroma-Q® reserves the right to change or make alteration to devices and their functionality without notice due to our on-going research and development.

The Chroma-Q® Inspire™ External Control Box UL924 has been designed specifically for the lighting industry. Regular maintenance should be performed to ensure that the products perform well in the entertainment environment.

If you experience any difficulties with any Chroma-Q® products please contact your selling dealer. If your selling dealer is unable to help, please contact support@chroma-q.com. If the selling dealer is unable to satisfy your servicing needs, please contact the following, for full factory service:

Outside North America:
Tel: +44 (0)1494 446000
Fax: +44 (0)1494 461024
support@chroma-q.com

North America:
Tel: 416-255-9494
Fax: 416-255-3514
support@chroma-q.com

For further information please visit the Chroma-Q® website at www.chroma-q.com.

Chroma-Q® and Inspire™ External Control Box UL924 are trademarks, for more information on this visit www.chroma-q.com/trademarks.

The rights and ownership of all trademarks are recognised.

Important Notice:

As per the requirements in the Occupational Safety and Health Administration standards for product approval, please refer to the OSHA web pages <http://www.osha.gov/dts/otpca/nrtl/> for information on the list of Nationally Recognized Testing Laboratories (NRTLs) and the scope of recognition.



Table of Contents

1. Product overview	6
2. Unpacking the Units.....	6
3. Cabling System	7
AC Mains Line Power Connection	8
AC Emergency/ Standby Line Power Connection	8
Data/DMX Connection	10
Connecting 0 – 10V Source (Control Bus).....	12
Alarm.....	12
4. Mounting	14
5. Menu	14
Change DMX Address screen:	15
Look Store screen	16
Setup screen:.....	16
6. Control Menu Setup	17
Address	18
Mode	18
Setup Menu.....	19
7. DMX Protocol	22
8. Troubleshooting	23
9. Specification	24
Technical Specifications	24
Drawings – Dimensions	25
10. Maintenance	26

Safety Information



WARNING!
Read the safety precautions in this section before installing, powering, operating or servicing this product.

The following symbols are used to identify important safety information on the product and in this document:



Warning!
Safety Hazard.
Risk of severe injury or death.



Warning!
Fire Hazard.

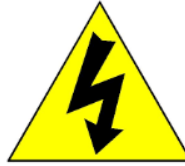

Warning!
Hazardous Voltage.
Risk of severe lethal electric shock.



Warning!
Refer to User manual.

Warning!

Read the user manual before installing and operating the Chroma-Q® Inspire™ Control Box UL924. For future reference, keep and use the manual.

Safety precautions given in user manual must be followed at all times and the manuals of all the devices you connect it to. Observe all the warnings printed on product and in manuals. Make sure whoever is involved in working on or using the Chroma-Q® Inspire™ Control Box UL924 has carefully read and understood all the safety precautions and listed warnings.

Install, connect, operate and service devices only as described in this manual and in connected devices' manuals and only in accordance with local laws and regulations. All Chroma-Q® manuals are available for download from www.chroma-q.com.

Chroma-Q® Inspire™ Control Box UL924 does not have user-serviceable parts. Refer any operation not described in this manual to support@chroma-q.com.

If you experience difficulties with any Chroma-Q® products please contact your local dealer. If your local dealer is unable to help then please contact support@chroma-q.com.

If you are having trouble finding what you are looking for on our website, then contact our Chroma-Q® marketing department by sending an email to marketing@chroma-q.com.

PROTECTION FROM ELECTRIC SHOCK

- Use only the cables specified in this manual and on the Chroma-Q® website at www.chroma-q.com to interconnect devices in the installation. If the specified cables are not long enough for an intended cable run, consult Chroma-Q® for assistance in finding or creating a safe alternative solution.
- Provide a means of locking out AC mains power that allows power to the installation to be shut down and made impossible to reapply, even accidentally, during work on the installation.
- Shut down power to the installation during service and when it is not in use.
- Before applying power to the installation, check that all power distribution equipment and cables are in perfect condition and rated for the current requirements of all connected devices.
- Isolate the installation from power immediately if any product, power cable or power plug is in any way damaged, defective or wet, or if it shows signs of overheating.
- Do not immerse a Chroma-Q® Inspire™ Control Box UL924 fixture in water or expose it to high-pressure water jets.

PROTECTION FROM BURNS AND FIRE

- The Inspire™ Control Box UL924 is convection cooled. Provide free airflow around the fixture and a minimum clearance of 10 mm (0.4 in.) in all directions.
- Do not operate the Inspire™ Control Box UL924 if the ambient operating temperature exceeds 55° C (131° F).
- Do not modify the Inspire™ Control Box UL924 in any way not described in this manual or install other than genuine Chroma-Q® parts. Use only accessories approved by Chroma-Q®.

PROTECTION FROM INJURY

- Ensure that the installation hardware and supporting surface or structure can hold at least 10 times the weight of all the devices they support.
- Block access below the work area and work from a stable platform whenever installing, servicing or moving the Inspire™ Control Box UL924.
- As soon as work is completed, check that all hardware and components are securely fastened to supporting structures.
- Make sure there are no flammable materials close to the product during operation.
- Make sure the power cord is not crimped or damaged.
- Avoid direct eye exposure to the light source while the product is on.
- Never try to repair the product. Repairs carried out by unskilled people can lead to damage or malfunction and/or invalidate your warranty. Please contact the nearest authorized dealer or contact support@chroma-q.com.



Keep this User Manual for future consultation. If this product is used by another user, be sure that they also receive this document.

1. Product overview

The Inspire™ External Control Box UL924 is a 19" rack mount external remote addressing unit for the control of the Inspire™ Terminal Strip fixtures via DMX 512.

Three control data output ports are available for the control of up to 128 daisy-chained fixtures from each port. DMX data input and through connections from an external DMX control console are via XLR 5-pin.

The Inspire™ External Control Box UL924 is built with Plug-in Terminal Block connectors for AC power input, Emergency power input, control data output signals and XLR DMX In and Thru connections.



2. Unpacking the Units

ITEM	Description	Qty.	Model
1	External Control Box UL924 unit	1	632-5010
2	Quick Start Guide	1	632-0708
3	Plug-in terminal blocks for control data output	3	900-2214
4	Resistors 120 Ω (temporarily attached to the terminal blocks)	3	900-0925
5	Plug-in terminal blocks for AC power input and Emergency power input	2	900-2220
6	Power Cord	2	632-0306
7	Strain Relief for power wire	2	631-0053
8	Strain Relief for DMX in/out wires	3	631-0054

The original shipping packaging is durable and is specially designed for the purpose of reusability. It is recommended that it is retained, for shipping the fixture.

3. Cabling System

The Inspire™ External Control Box UL924 has 3 control data outputs (Port 1, 2, 3). Each control data output provides remote control for up to 128 daisy-chained Inspire™ Terminal Strip fixtures. The maximum length of the DMX cable from each data output of the External Control Box to the **first** Terminal Strip fixture must not exceed 500 ft (152 m).

Figure 1: System Diagram

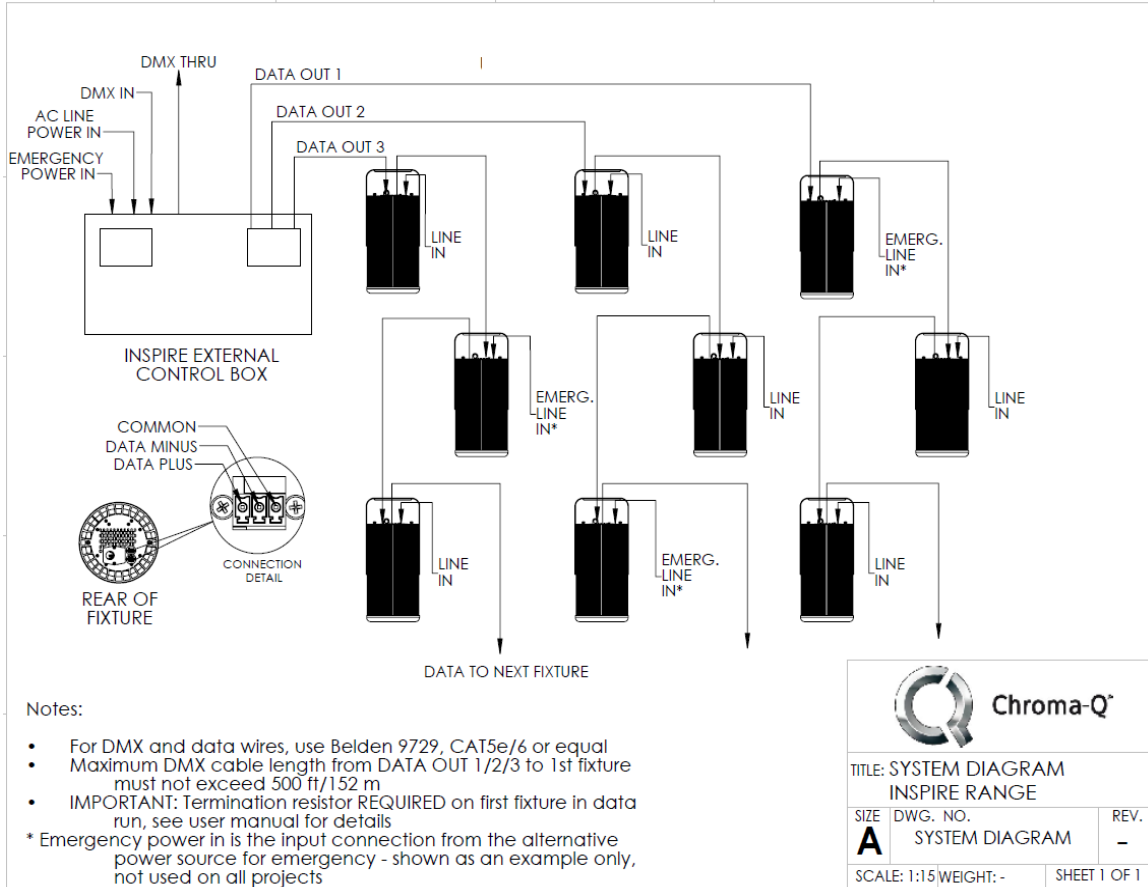

Note: A cable longer than 100' between two fixtures should be terminated with a 120 ohms resistor on the input side.

CAUTION:

The Inspire™ External Control Box UL924 has more than one power supply connection point. To reduce the risk of electric shock, disconnect both the branch circuit-breakers or fuses and emergency power supplies before servicing.

AC Mains Line Power Connection

To connect the wiring of the AC power input cable: (Figure 2 & 3)

1. Remove the Power Input Cover Plate using #1 Phillips screwdriver
2. Pull and remove the plastic covers of the AC and Emergency power cord entry holes
3. Insert the AC power cable with the appropriate cable strain relief through the power cord entry hole
4. Unplug the AC power Terminal Block Plug from the Header
5. Connect the wiring for the AC power cable into the Terminal Block Plug using Ø 1.8mm slotted screwdriver
6. Pull back on the wire to be sure it is secure and check there are no wire strands outside the terminal block
7. Plug the wired AC power Terminal Block Plug into the Terminal Block Header
8. Fasten the AC grounding wire onto the stud for grounding connections
9. Fasten cable strain relief
10. Proceed to wire the Emergency power input cable

Note:

If your system uses single phase power, connect to Neutral and Live 1 with jumpers to Live 2 and Live 3.

When power is supplied to both emergency and Regular Power, it operates normally. When Regular power is taken off the emergency power kicks in.

AC Emergency/ Standby Line Power Connection

To connect the wiring of the Emergency power input cable: (Figure 2 & 3)

(If your system does not have Emergency power, disregard this section.)

11. the Emergency power cable with the appropriate cable strain relief through the power cable entry slot
12. Unplug the Emergency power Terminal Block Plug from the Header and connect the wiring for the Emergency power cable into the Terminal Block Plug using Ø 1.8mm slotted screwdriver
13. Plug the wired AC power Terminal Block Plug into the Terminal Block Header
14. Fasten the Emergency grounding wire onto the stud for grounding connections (Ensure the use of appropriate ring terminals, star washers and nuts)
15. Fasten cable strain relief
16. Put back and fasten the cover plate

Figure 2: AC and Emergency Power Connection

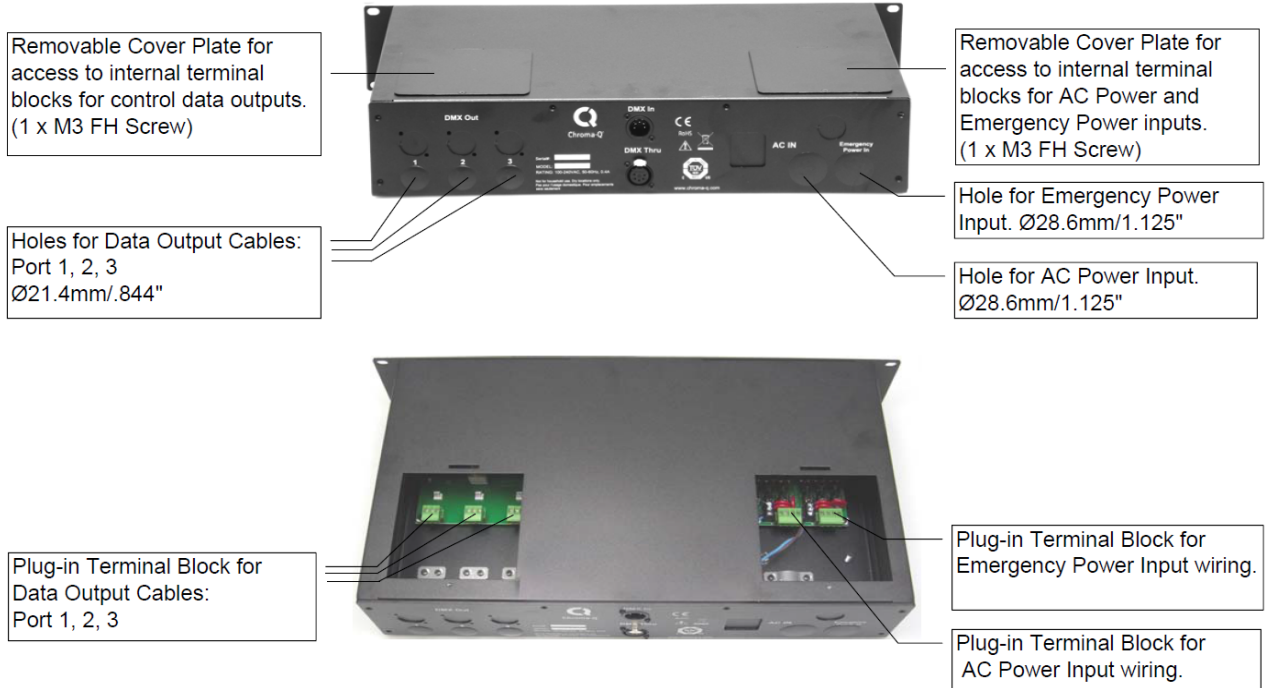
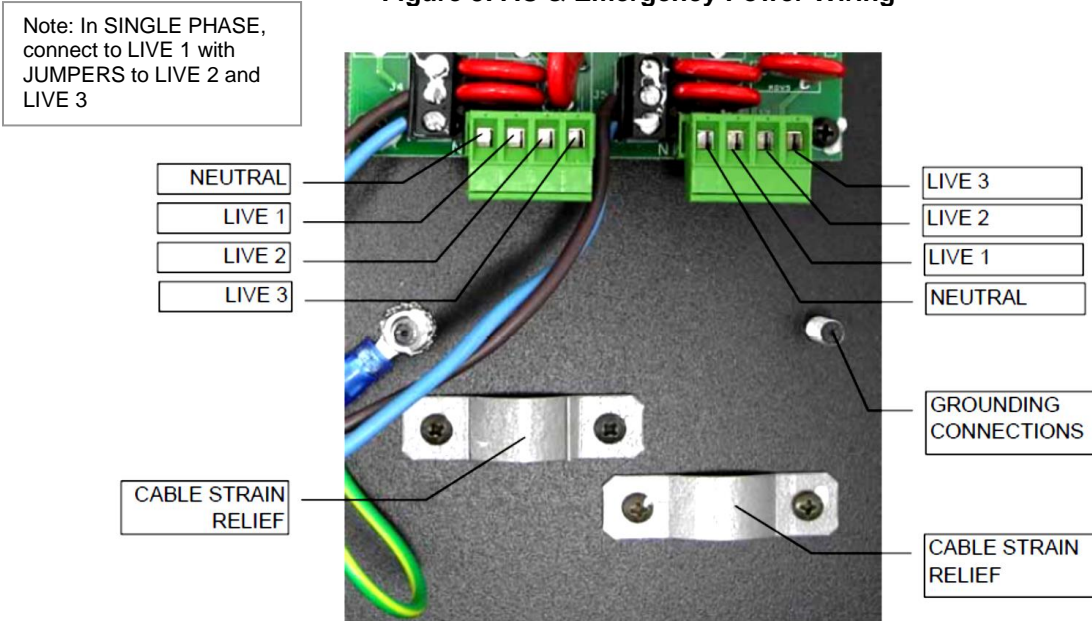

Figure 3: AC & Emergency Power Wiring



CAUTION:

Provide conduit/armoured connection for each Data Output Cable. (Min 20MSG metal plate)

Data/DMX Connection

To connect the wiring of the control data cables: (Figure 2 & 4)

1. Remove the data output cover plate using #1 Phillips screwdriver
2. Pull and remove the plastic covers of the data cord output holes (Port 1, 2, 3)
3. Insert the data cable for each port through the data cord output hole with the appropriate cable strain relief corresponding/adjacent to each Terminal Plug location
4. Unplug each Terminal Block Plug from the Header
5. Connect the wiring for each of the data cable into the Terminal Block Plug using \varnothing 1.8mm slotted screwdriver
6. Pull back on the wire to be sure it is secure and check there are no wire strands outside the terminal block
7. Plug the wired data output Terminal Block Plug into the Terminal Block Header
8. Fasten the cable strain reliefs of each data cable using #1 Phillips screwdriver
9. Put back and fasten the cover plate

Figure 4: Data Output Wiring

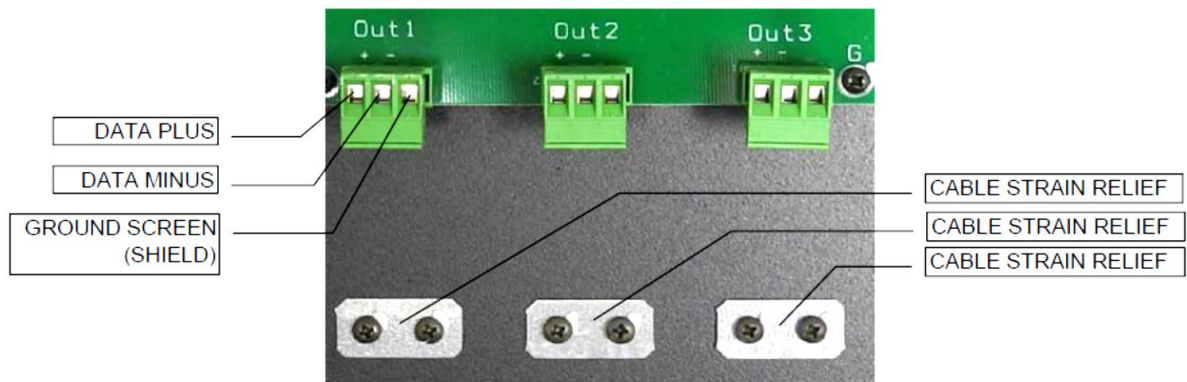

XLR 5-pin Cable:

Pin#	Function
1	Common (Screen)
2	Data Minus
3	Data Plus
4	Spare Data Minus
5	Spare Data Plus

Power Cable Color Code:

EU	North America	Connections	
Green and Yellow	Green	Earth (E)	Ground (Green)
Blue	White	Neutral (N)	Neutral (Silver)
Brown	Black	Live (L)	Hot (Gold)

EU	North America	Connections
Green and Yellow	Green	Earth/Ground
Brown	Black	Line 1 Phase A
Black	Red	Line 2 Phase B
Gray	Blue	Line 3 Phase C
Blue	White	Neutral
For other areas, consult your local jurisdiction.		

Important Notice: The use of an opto-splitter for DMX signal distribution is highly recommended when several control boxes are not plugged into the same power source.

Connecting 0 – 10V Source (Control Bus)

This mode controls the Inspire™ XT fixtures over DMX, pin polarity is shown in Fig 6.

When put at this mode, by tapping on 0-10v bus button in the change mode screen,

1. The control box disregards the current DMX input and controls the connected light fixtures over the DMX output according to the 0-10v input voltage.
2. At 0v the light intensity goes to minimum (0%) and the 10v the light intensity goes to maximum (100%). 1v input corresponds to 10% rise in intensity, 2v to 20% and so on.
3. All the connected Inspire™ fixtures are automatically set to one preset color (white) only.
4. Inspire™ Terminal Strip fixtures cannot be changed to any other color than white.

Alarm

In the alarm situations, the building control panel sends a short signal to the alarm port on the UL924 box, which closes the dry contact, Fig6.

1. This setting has the highest priority over all other UL 924 box settings.
2. This will trigger the Inspire™ XT fixtures to a default white color at 100% intensity alarm look. A top-level block diagram is shown in fig5.
3. Alarm look on the Inspire™ fixtures can be changed and pre-set to desired color and intensity using a DMX controller.
4. In an alarm situation, the red LED on the UL924 box overlay will start fast flashing with a continuous audible fast beep.

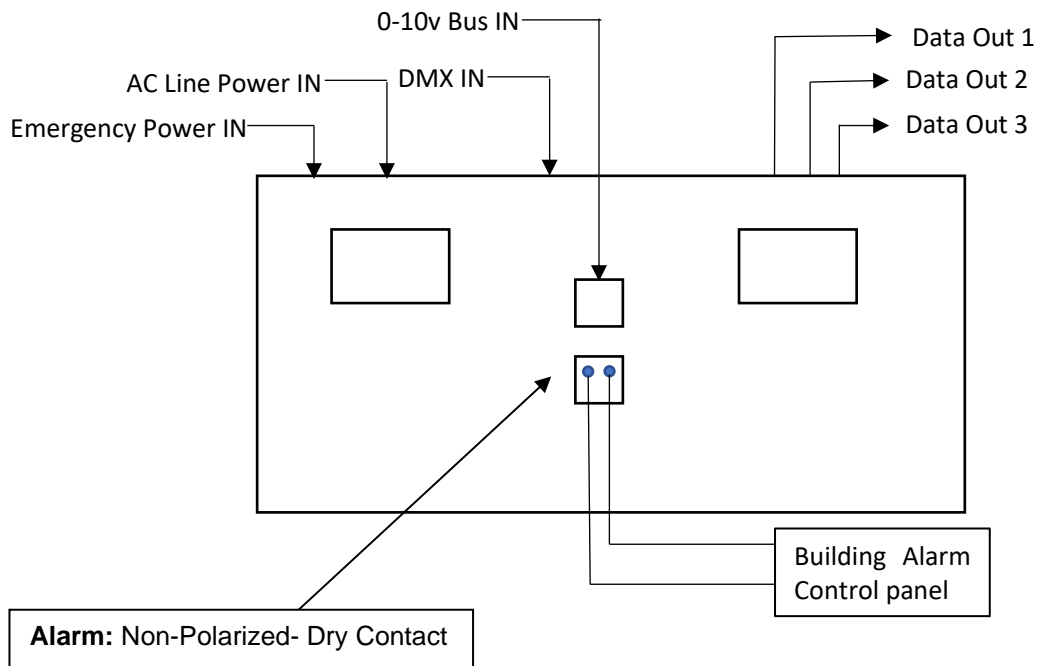
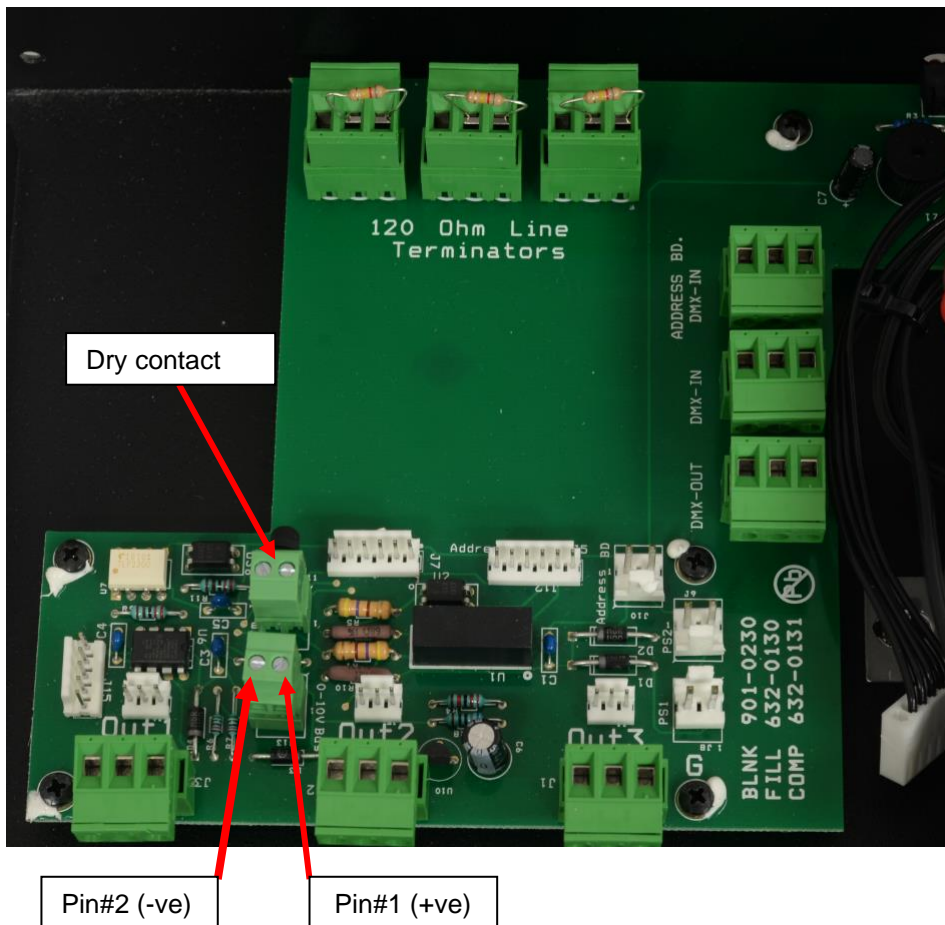
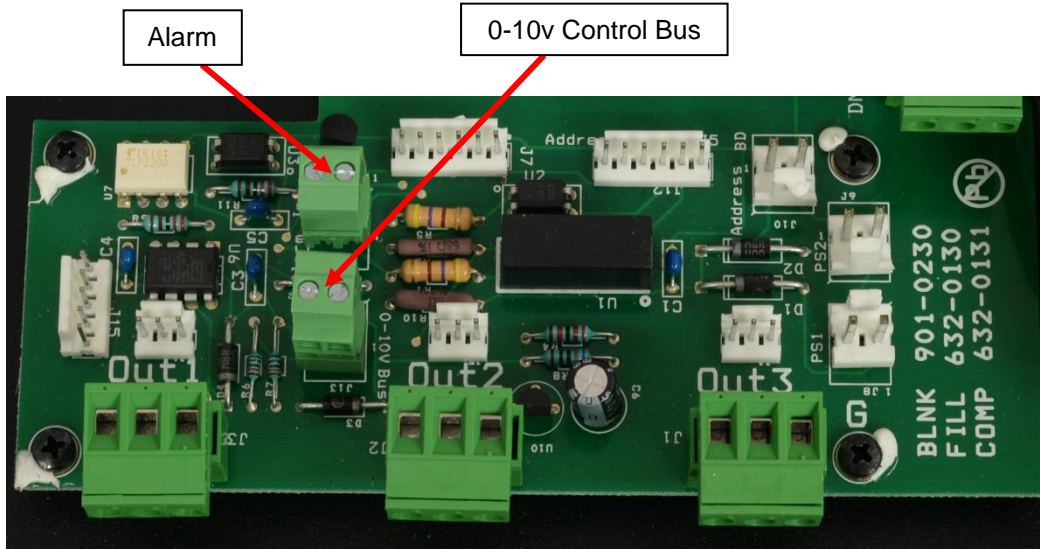

Figure 5

Figure 6: Alarm and 0-10v Bus



4. Mounting

The Inspire™ External Control Box UL924 is built with a standard 19" rack mount enclosure.

5. Menu

The Inspire™ External Control Box UL924 provides remote control of the Inspire™ Terminal Strip fixtures. The control functions can be accessed through the Touch Screen Display at the front panel.

Opening Screen on Power On:



Main Screen:



Data Signal Indicator	">>>DMX" DMX signal from a remote DMX control console is present, or "No Data" if there is no DMX signal present
AC Power Indicator	AC power is connected on each of the 3 phases (L1, L2, L3)
Emergency Power Indicator	Emergency power is connected on each of the 3 phases (E1, E2, E3)
DMX Start Address	Assigned DMX start address for each DMX output
Command Button	Can be tapped to access and select control menu screens and options

Change DMX Address screen:



Command Buttons:
Tap to access each
Port (DMX output)



The screen shows the current DMX start address and the new DMX start address. In the screen, the numeric command buttons can be tapped to set the new DMX start address.

Command Button	Description
0 – 9	Button numbers 0 to 9 for typing the new DMX start address.
Apply	Save the new DMX address.
Escape	Exit the screen without saving.

Change Mode screen:



The table shows the control options available in the Change Mode screen:

Command Button	Description
RGBW single	4 channels for Red, Green, Blue & White per fixture in a single output (512 channels for a maximum of 128 fixtures per single output)
RGBW output	4 channels for Red, Green, Blue & White per output
Tungsten	1 channel for White for all fixtures per output
0-10V	1 channel for 0 – 10V dimming control
LookStore	A Look can be recorded in the LookStore screen and set as an output option when DMX is not present (see DMX Lost)
Apply	Save the settings
Escape	Exit the screen without saving

Look Store screen



The table shows the options available in the Look Store screen:

Command Button	Description
LoadLook	Recall and playback the saved Look.
SaveLook	This command button saves the current output setting.
SaveEmergency	This command button saves the current output setting that will turn ON when power is automatically switched to Emergency (loss of Main Power). Default emergency output setting is white at 100% intensity.
SaveAlarm	This command button saves the current output setting that will turn ON when in the alarm goes off. Default output setting is white at 100% intensity.

Setup screen:



The table shows the fixture setup options available in the Setup screen:

Command Button	Description
DMX Data	Displays the DMX start address and the levels for all the channels assigned.
RotateDisp	The command rotates the orientation of the Touch Screen Display
Frequency	4 frequency options are accessed through the PWM Frequency screen: 1200Hz, 2400Hz, 4800Hz, 9600Hz
DMX Lost	The fixture can be set with 3 options when DMX data is lost: Last data – holds the last valid DMX state No Output – the fixture switches to off Look – sets the recorded Look
Reset	Reset Settings options are accessed through the Reset Setting screen: Default – Factory default settings User – User defined settings
Escape	Exit the screen without saving.

6. Control Menu Setup

The Control Menu options are accessed through the Touch Screen Display at the front of the Inspire™ External Control Box.

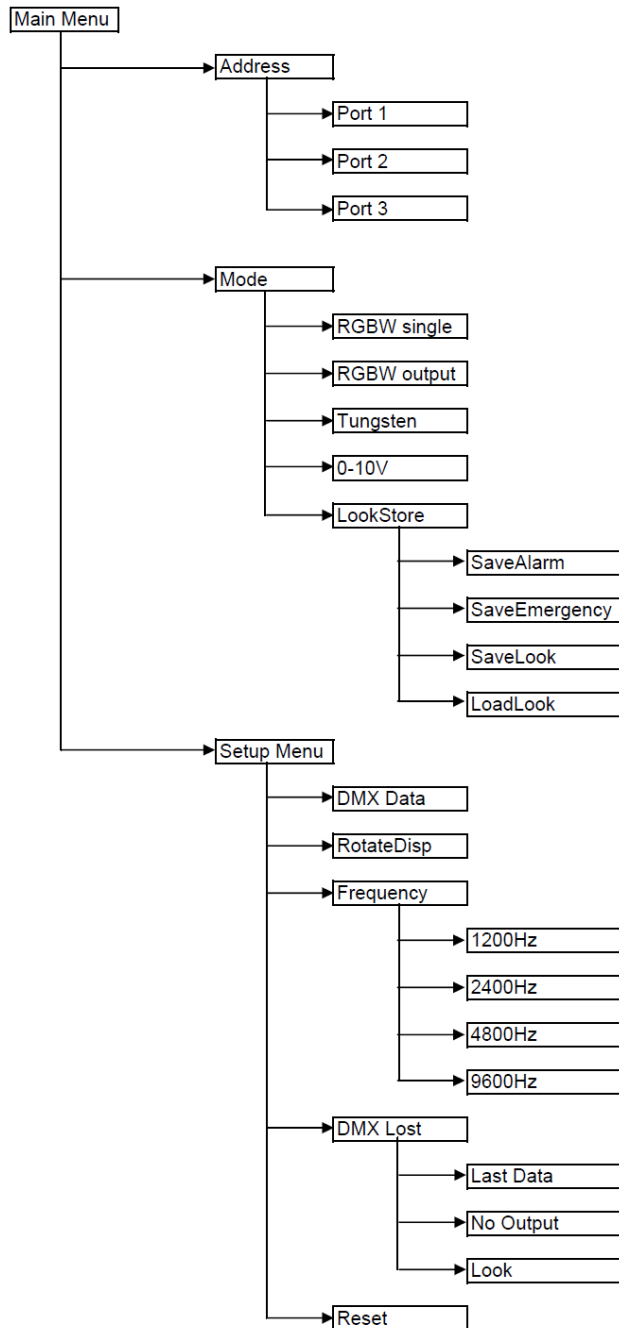

To access the control options:

- From the Main Menu, tap the command buttons to access menu screens
- In the Menu screens, select and tap a command option
- Tap **Apply** to save the new setting or
- Tap **Escape** to exit without saving and go back to the previous menu

Main Menu

The Main Menu displays the port number and the current assigned DMX start address, and the 3 command buttons:

- **Address**
- **Mode**
- **Setup Menu**

Select and tap a command button to access the main control options available.

▶ Address

To set the DMX start address,

1. On the Main Menu screen, tap **Address**
2. Select and tap a Port, the screen goes to the DMX Address screen,
3. Using the buttons, type the desired number
4. Tap **Apply** to save

The display goes back to the Main Menu with the new DMX address.

▶ Mode

In this menu, the fixture can be set to operate in various DMX controlled modes.

RGBW single
RGBW output
Tungsten
0-10V
Look Store

▶ RGBW single

This mode assigns 4 channels for Red, Green, Blue & White for each individual fixture in each output.

To set the RGBW single mode,

1. On the Main Menu, tap **Mode**
2. On the Mode screen, tap **RGBW single**
3. Tap **Apply** to save or **Escape** to cancel

The display goes back to the Main Menu.

▶ RGBW output

This mode assigns 4 channels for Red, Green, Blue & White for all the fixtures in each output.

To set the RGBW output mode,

1. On the Main Menu, tap **Mode**
2. On the Mode screen, tap **RGBW output**
3. Tap **Apply** to save or **Escape** to cancel

The display goes back to the Main Menu.

▶ Tungsten

This mode assigns 1 channel for White for all the fixtures in each output.

To set the Tungsten mode,

1. On the Main Menu, tap **Mode**
2. On the Mode screen, tap **Tungsten**
3. Tap **Apply** to save or **Escape** to cancel

The display goes back to the Main Menu.

- ▶ 0-10V
This mode assigns 1 channel from the external analog control source.
To set the 0-10V mode,
 1. On the Main Menu, tap **Mode**
 2. On the Mode screen, tap **0-10V**
 3. Tap **Apply** to save or **Escape** to cancel
 The display goes back to the Main Menu.

- ▶ Look Store
In this menu, 3 distinct looks can be stored for playback:

Alarm	This look has the highest priority and is played back in the event of a dry contact closure provided from an external alarm system. This look overrides the DMX input.
Emergency	This look is triggered when Main power is lost and Emergency Power is active. This look overrides the DMX input at the Mains power.
Look	This look can be recalled from the control box or selected to be played in the event of DMX loss.

Note: All looks are programmed in default with all DMX values to 80%.

A Look or preset can be created with a DMX controller and played back using Look Store.

To save a Look,

1. Create a Look with your console
2. Tap **Mode**, then **Look Store**
3. On the Look Store screen tap and hold the look type you want to record. A text prompt appears on the display indicating the Look is stored. The saved Look can be loaded and played back.

To Load a Look in Look Store,

1. Create a Look with your console using the steps above
2. Tap **Mode**, then **Load Look**

▶ Setup Menu

In this menu, internal settings can be re-configured.

DMX Data
RotateDisp
Frequency
DMX Lost
Reset

- ▶ DMX Data
In this menu, the screen shows the DMX start address and the equivalent value for each of the DMX channels assigned.
To show DMX Data,
 1. On the Main Menu, tap **Setup Menu**
 2. On the Setup screen, tap **DMX Data**
 Tap **Escape** to exit.

► **RotateDisp**

This command rotates the display screen by 180 degrees.

To rotate the display screen,

1. On the Main Menu, tap **Setup Menu**
2. On the Setup screen, tap **RotateDisp**

The display screen rotates by 180 degrees.

► **Frequency**

In this menu, the fixture can be set to four frequency options. The LED scan rate can be synchronised with the video camera to avoid a flickering effect.

Frequency options:

1200 Hz
2400 Hz
4800 Hz
9600 Hz

To set the Frequency,

1. On the Main Menu, tap **Setup Menu**
2. On the Setup screen, tap **Frequency**
3. On the PWM Frequency screen, select and tap a Frequency option, then tap **Apply** to save.

The screen goes to the Setup screen.

► **DMX Lost**

In this menu, output options can be selected if the fixture does not detect DMX signal:

Output options:

Last data	Fixture holds the last valid DMX state
No output	Fixture output is off
Look	Saved Look in LookStore

To set DMX Lost,

1. On the Main Menu, tap **Setup Menu**
2. On the Setup screen, tap **DMX Lost**
3. On the DMX Lost screen, select and tap an output option
4. Tap **Apply** to save

The screen goes to the Setup screen.

► **Reset**

In this menu,

- Current user settings can be saved.
- The unit can be reset to the saved user settings.
- The unit can be reset to the factory default settings. All recorded Looks are erased.

To save the current user settings,

Review all settings.

1. On the Main Menu, tap **Setup Menu**
2. On the Setup screen, tap **Reset**
3. On the Reset Setting screen, press and hold **Save User** for 10 seconds to save the current settings. (Follow the text prompt that appears on the screen.)

The screen goes to the Setup screen.

To reset to the saved user settings,

1. On the Main Menu, tap **Setup Menu**
2. On the Setup screen, tap **Reset**
3. On the Reset Setting screen, tap **User**
4. Press and hold **Apply** for 3 seconds to restore the saved user settings

The screen reboots to the opening screen and Main Menu.

To reset to the factory default settings,

1. On the Main Menu, tap **Setup Menu**
2. On the Setup screen, tap **Reset**
3. On the Reset Setting screen, tap **Default**
4. Press and hold **Apply** for 3 seconds to restore the factory default settings.

The screen reboots to the opening screen and Main Menu.

Factory Default Settings:

DMX Address	Port1:1, Port2: 2, Port3:3
Mode	RGBW single
DMX Lost	Last data
Frequency	1200Hz
Reset	Default
Mains power output color	White at 100% intensity
Emergency Power output color	White at 100% intensity
Alarm state output color	White at 100% intensity

7. DMX Protocol

V1.01	RGBW single [128 ch per output] RGBW	RGBW output [4 ch per assigned output] RGBW	Tungsten [1 ch] W
Channel 1	Red for fixture 1	Red for output	White for all fixtures (RGBW combined)
Channel 2	Green for fixture 1	Green for output	
Channel 3	Blue for fixture 1	Blue for output	
Channel 4	White for fixture 1	White for output	
Channel 5	Red for fixture 2		
Channel 6	Green for fixture 2		
Channel 7	Blue for fixture 2		
Channel 8	White for fixture 2		
Channel 9	Red for fixture 3		
Channel 10	Green for fixture 3		
	...and so on up to fixture 32 per output		
Total	128 DMX channels per output	4 DMX channels per output	1 DMX channel

8. Troubleshooting

Troubleshooting is a process of elimination. First, rule out the other field factors (i.e. bad connections, faulty cables and power supplies). For technical support and/or parts, please contact your selling dealer or the offices listed in this manual.

Symptom	Possible Cause	Solution
Fixture does not respond to DMX control.	<ul style="list-style-type: none"> • The External Control Box is set to the wrong or different DMX address. • Bad cable connecting DMX control and External Control Box. • Bad cable connecting DMX control and fixture. • Bad in/through connection between daisy-chained fixtures. • Bad in/through connection between daisy-chained External Control Boxes. 	<ul style="list-style-type: none"> • Check DMX address and Mode settings. • Check/replace DMX run from the console to the External Control Box. • Check/replace DMX runs from the External Control Box to the fixtures. • Check/replace DMX runs between daisy-chained fixtures. • Check/replace DMX runs between daisy-chained External Control Boxes.
Low LED output.	<ul style="list-style-type: none"> • Internal temperature of the fixture is over the limit. 	<ul style="list-style-type: none"> • Check area ventilation.
Flicker	<ul style="list-style-type: none"> • No termination resistor 	<ul style="list-style-type: none"> • Check the first fixture in each run if it has the 120 Ω terminating resistor.

9. Specification

Technical Specifications

Net Dimensions** (Without Fixings - Width x Height x Depth)	483mm x 88mm x 254mm / 19" x 3.5" x 10"
Net Weight (Without Fixings)	2.5kg / 5.5lb
Shipping Dimensions – Width x Height x Depth	533mm x 317.5mm x 133.5mm / 21" x 12.5" x 5.25"
Shipping Weight	3.3kg / 7.3lb
Color	Black
Construction	Powder-coated aluminum
Power & Connections	
Power Supply	Built-in
Power Input Rating	100-240V AC 50-60Hz .4A
Power Factor	0.6
Power Consumption	4.6W @ 120V AC; 9W @ 230V AC
Inrush Current	11A @ 120V AC; 23A @ 230V AC
Idle Power Consumption	4.6W @ 120V AC; 9W @ 230V AC
Typical Power & Current	Measurements done with all LEDs at maximum intensity. Measurements made at nominal voltage. Allow for a deviation of +/- 10%.
Power connector In/Out	Input only: Internal Terminal Block; Transfer Power Input from Generator: Internal Terminal Block
Data Connectors In/Out	Terminal Block
Control Protocol	ANSI E1.11 USITT DMX 512-A
Control Modes	RGBW single, RGBW output, Tungsten, 0-10V , LookStore
Dimming Curve	Theatrical
Operating Condition, IP Rating and Approvals	
Cooling System	Convection
Operating Temperature	0°C to 40°C
IP Rating	IP20
Approvals	CISPR 22/EN55022 & CISPR 24/EN55024, ICES-003 Issue 4:2012 / FCC Part 15 Subpart B:2014, CSA C22.2 No. 166-M1983: R2013, UL 1573:2003 R2014, IEC 60598-2-17, UL924

Drawings – Dimensions

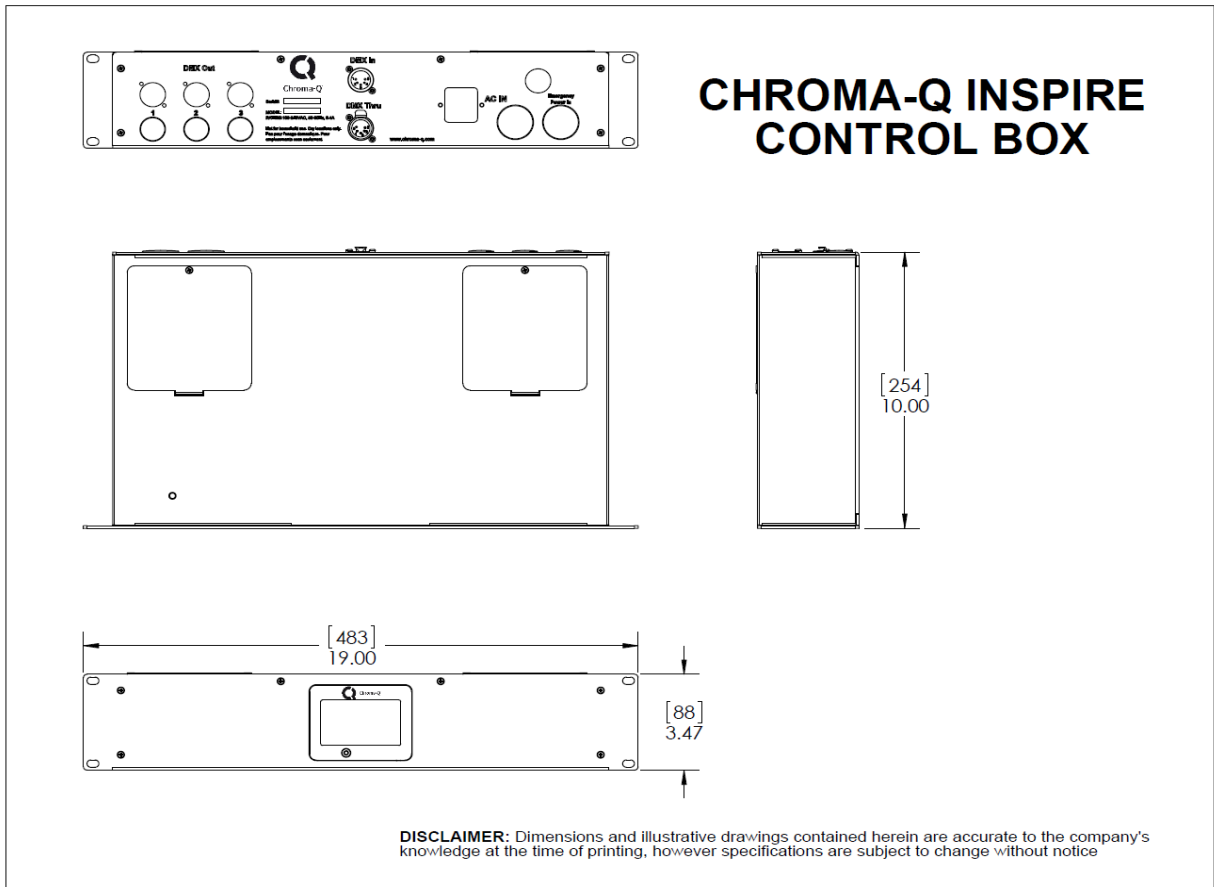

10. Maintenance

With care, the Inspire™ External Control Box UL924 requires little maintenance. However, as the unit is likely to be used in a stage environment, we recommend periodic inspection and cleaning of any accumulated debris.

Do not spray liquids on the front or rear panel. If the front enclosure requires cleaning, wipe with a mild detergent on a damp cloth.